

Intelligent Electromagnetic
Flowmeter Products Brochure
LDG



COMPANY PROFILE

The company is a professional research and production enterprise of flowmeter. Through a long period of exploration and accumulation, the company has formed a complete set of business system from the research, development, production, testing, sales to after-sales service.

Now the company mainly produces intelligent electromagnetic flowmeter, V-cone flow sensor, vortex flowmeter, flow totalizer and other products. The company has designed and manufactured the most advanced flowmeter at present in the world. All products have passed real-flux inspection by calibration before leaving factory.

WE will continue to rely on technology to provide the best product quality and after-sales technical support to serve both new and old customers. The company will also strive to make its due contributions to promote flowmeter technology in China.



Contents

ADVANTAGES of product

- **First - class production facilities**
- **Durable and stable quality**
- **Each product is subject to real flux calibration before leaving the factory**
- **Trouble-free installation and operation**
- **Professional tracking service**

03	Working Principle of Electromagnetic Flowmeter
06	Features
06	Technical Service and Matters That Need Special Attention
07	How to Use the Instrument Correctly
07	Installation and Structure
08	Normal Working Conditions
08	Technical Index
09	How to Choose A Right Model
10	Range of Measurable Flux
11	Instructions to Wiring
12	Display and Setup Instruction of Electromagnetic Flowmeter in Working Condition
17	Flowmeter Model Description
18	Outline Dimension of Integral Flowmeter
19	Technical information

Working Principle of Electromagnetic Flowmeter

The working principle is based on Faraday's Law of Electromagnetic Induction, that is, when the conductive liquid flows through the electromagnetic flowmeter, the induced electromotive force will be produced in the conductor, and the induced electromotive force is directly proportional to the velocity of conductive liquid, magnetic flux density and width of conductor (inside diameter of flowmeter).

Such induced electromotive force is detected by a pair of electrodes on the tube wall of the flowmeter, and the rate of flow can be acquired by mathematical operation. The equation of induced electromotive force is as follows:

$$E = D \cdot V \cdot B$$

- E: induced electromotive force,
- D: inside diameter of measuring pipe
- V: velocity
- B: magnetic flux density.

The following conditions should be satisfied in order to obtain satisfactory measuring accuracy:

- (1) The tested liquid shall possess the electrical conductivity;
- (2) The pipe shall be full of liquid;
- (3) The components of liquid shall be well mixed;
- (4) If the liquid has magnetic permeability, the magnetic field of the flowmeter will change, so the flowmeter shall be modified.

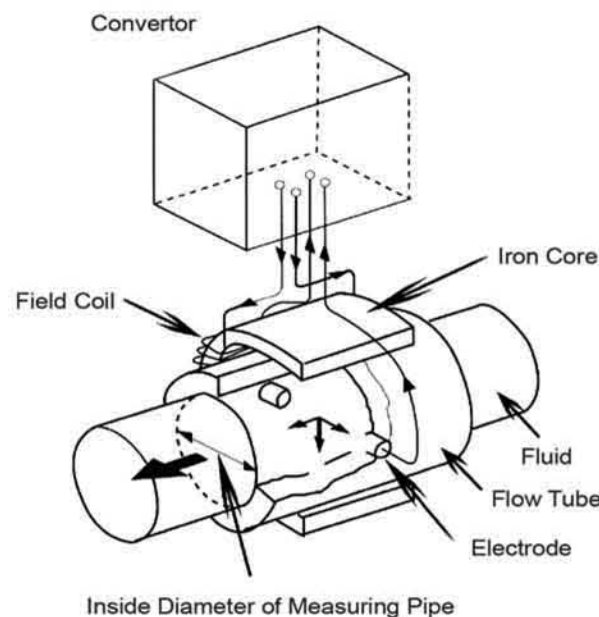

Aperture	10-3200
Excitation Type	Constant Flux Square wave Excitation
Installation Form	Integral
Lining	Chloroprene Rubber, Polyurethane Rubber, PTFE, F46
Material of Electrode	316L, HC, HB, Titanium, Tantalum, Platiniridium, Tungsten Carbide
Grounding	Built-in Grounding Electrode (above DN25)
Medium	Conductive Liquid
Grade of Accuracy	0.2, 0.5, 1.0
Conductivity of Medium	>5μS/cm
Velocity	≤15m/s
Pipe Connection Flange	GB9119-2000 or GB9115-2000
Pipe Connection	Flange Connection
Temperature of Medium	Chloroprene Rubber: -10℃ ~ +60℃; PTFE: -10℃ ~ +120℃ Polyurethane Rubber: -10℃ ~ +80℃; F46: -10℃ ~ +150℃
Rated Voltage	4MPa, 1.6MPa, 1.0MPa
Category of Shielding	IP65, IP68
Output Signal	4-20mA Current, Pulse Frequency, Alarm for Upper and Lower Limits
Cable Interface	M20×1.5
Communication	RS485 Communication Protocol RS232 Communication Protocol (Optional)
Display of Monitor	Transient Flux Alarm Display, Percentage, Velocity, Forward and Reverse Integrated Flux and Total Integrated Flux
Power Supply	220V AC, 24V DC, 3.6V Battery Power Supply
Type of Application	General Type, Waterproof Type
* High Voltage	Custom-made

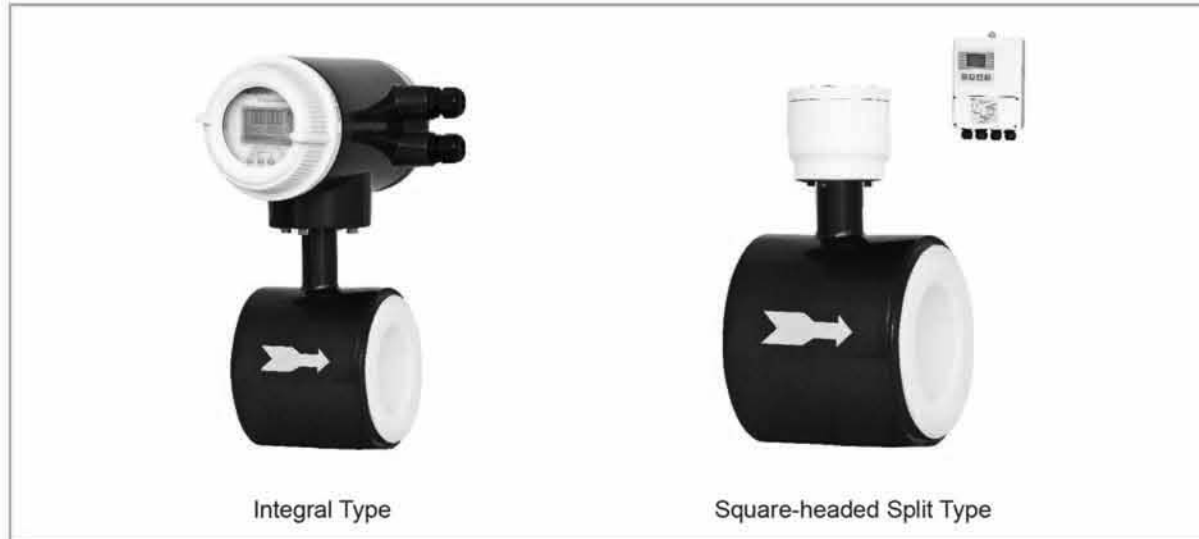

Aperture	10-3200
Excitation Type	Constant Flux Square wave Excitation
Installation Form	Split Type
Lining	Chloroprene Rubber, Polyurethane Rubber -10℃~+80℃; F46: -10℃~+150℃, PTFE, F46
Material of Electrode	316L, HC, HB, Titanium, Tantalum, Platiniridium, Tungsten Carbide
Grounding	Built-in Grounding Electrode (Above DN25)
Medium	Conductive Liquid
Grade of Accuracy	0.2, 0.5, 1.0
Conductivity of Medium	>5μS/cm
Velocity	≤15m/s
Pipe Connection Flange	GB9119-2000 or GB9115-2000
Pipe Connection	Flange Connection
Temperature of Medium	Chloroprene Rubber: -10℃~+60℃; PTFE: -10℃~+120℃ Polyurethane Rubber: -10℃~+80℃; F46: -10℃~+150℃
Rated Voltage	4MPa, 1.6MPa, 1.0MPa
Category of Shielding	IP65, IP68
Output Signal	4-20mA Current, Pulse, Alarm beyond upper and lower limits
Cable Interface	G1/2 Female Thread
Communication	RS485 Communication Protocol RS232 Communication Protocol (Optional)
Display of Monitor	Transient Flux Alarm Display, Percentage, Velocity, Forward and Reverse Integrated Flux and Total Integrated Flux
Power Supply	220V AC, 24V DC, 3.6V Battery Power Supply
Type of Application	General Type, Waterproof Type
* High Voltage	Custom-made



The electromagnetic flowmeter, as the product of long-term experience in the field of flux instrument, has the functions of rapid response and output noise elimination. Its design and quality control system have guaranteed the high accuracy and reliability of the product, and the application of lining makes the electromagnetic flowmeter applied more widely.

Features

- The stability of flux measurement has been improved
- Rapid response and high stability, even for highly concentrated serous fluid and fluid with low conductivity
- Electrode structure with high reliability
- Lining and built-in grounding electrode are both applicable
- Diameter from 10mm to 3200mm
- Both AC and DC power supplies are available
- Multi-functional Intelligent Converter
- When in power failure, EEPROM may protect the set parameters and accumulated values
- High-definition LCD Backlight Display.

Technical Service and Matters That Need Special Attention

- For users to meet the required conditions, we can provide on-site commissioning.
- For delivery, you must carefully read the instruction manual and consider the instrument installation location.
- For specified operations, parameters, setup and maintenance, maintenance personnel must read in whole or part, and understand it. In particular, operation requirements must comply with the instrument provisions, and we do not bear any responsibility of the consequences due to violations.
- Technical materials must be put in the file room for reference, and they are available from us or other agencies if lost.
- Under normal operation, we guarantee that every product is free from quality problems. We provide one year warranty for the product from the delivery date, and one-year repair and maintenance warranty for the parts and the product.
- The warranty is not applicable for the damage of the products caused by wrong selection of model, wrong operation, refitting, negligence, accident or the operation and treatment under normal conditions.
- The users shall record the data at least on daily basis when using the instrument, and enter into the agreement with the relevant units and individuals about the data processing when the instrument goes out of order. We bear no responsibility for the loss therefrom.
- Installing and using the flowmeter shall be deemed as your accepting the above terms.

How to Use the Instrument Correctly

- The flowmeter has a certain use range; please make sure the purchased flowmeter meets your working conditions (flux, pressure and temperature) before installation.
- After unpacking, install as soon as possible, so as not to prevent the amplifiers and metal parts affected by adverse weather conditions or corrosion; flowmeter used must be completely clean in storage. Avoid installing the flowmeter in the place subject to great temperature changes and heat radiation for equipment; if it must be installed, it must have good thermal insulation of ventilation.
- The installation place shall be protected against mechanical vibration, collision and impact. If the flowmeter is installed in the pipeline with strong vibration, the pipeline either side the flowmeter shall be fixed at either side of the flowmeter.
- The pipeline where the flowmeter is to be installed shall be the front and back straight pipe sections as specified in the Manual, otherwise, it will affect the measuring accuracy of the flowmeter, or even damage the flowmeter.
- While welding flange or pipeline for installing the flowmeter, the flowmeter shall not be placed on the pipeline, so as to avoid damaging the electronic amplifying circuit.

How to Use the Instrument Correctly

- When the meter is put into operation, open the valve slowly and the valve opening time shall be no less than 2min.
- The flowmeter can be installed on horizontal or vertical pipelines. If it is installed on vertical pipelines and the tested medium is liquid, the liquid shall flow upwardly.
- The flowmeter shall be prevented from being installed near the outlet of valve, otherwise, the opening and closing of the valve will shorten the service life of the flowmeter and even damage the flowmeter. To facilitate the maintenance, bypass line is necessary, especially in the place where the fluid shall not be stopped in the process of production.
- It is preferred that the flowmeter be installed indoors. If it must be installed outdoors, moisture proof and sun proof measures shall be taken.
- Users must obey the instructions and alarms specified in the Manual so as to ensure the correct and safe operation.

Installation and Structure

Installation

- Separate Model: Converter, 50mm pipe or plane installation
- Combined Model: Combined with Sensor
- Wire Connector: ISO M 20 x1.5 Female Thread
- Wiring Terminal: M3 Screw
- Material of Shell: Aluminium Alloy

Structure

- General Model: Degree of Protection IP65
- Waterproof Model: (IP68)

Advantages

- Programmable frequency square wave excitation improves the stability of flux measurement, low power loss
- All-digital signal processing, strong anti-jamming circuit, reliable and correct measured value
- EM1 switching power supply design, applicable in a wide range of power supply voltage variation
- Programmable parameters configuration of Chinese menu, easy to operate
- Simple machines with low power consumption for data processing, surface-mounted SMT electronic components, stable and reliable circuit
- High resolution backlit LCD display
- Have a self-check and self-diagnostics function, able to identify the sensor tube, rectangular wave excitation pulse width adjustable, with slurry noise rejection function

Normal Working Conditions

Ambient Temperature: -20-60 C
 Rated Voltage of Power Supply:
 220V AC: 100V~240VAC
 DC: 24VDC

Technical Index

Technical Index of Electromagnetic Flux Converter Components.

Input Signal	Signal emitted from the sensor and directly proportional to the flux.
Output Signal	4~20mA DC (Load Resistance 0-750Ω)
Choose the pulse/alarm output by parameter setup.	
Pulse Output/Alarm Output	Rated Value: 30VDC,100mA
Communication Signal	RS485 communication protocol RS232 Communication Protocol (Select function)
Load Resistance:	250-600 (Including cable resistance)
Load Capacitance:	Maximum 0.22μF
Load Inductance:	Maximum 3.3mH
Space between Split Cables	≤100 cm
Input Impedance of Receiving Instrument:	≤100 cm
Setup of Measurement Range	The volumetric flux is set by the setup of volume unit, flux value and diameter of flowmeter
Volume Unit	m ³
Velocity Unit	mm
Diameter of Flowmeter	m/s
Display of Transient Flux	The flux unit and the range percentage are displayed.
Display of Integrated Flux:	The forward and reverse integrated flux and total integrated flux are displayed.
Pulse Output	The pulse quantity expressed in any flux unit may be output by the setup of an impulse ratio.
Width of Pulse	Duty ratio of 50% or fixed pulse width is available for users to choose.
Output Speed	10-400 (PPS) (Only applicable when the form of pulse output is selected).
Black-out Data Protection	Data will be stored by EEPROM without backup battery.
Forward and Reverse Flux Measurement	In the model of forward and reverse flux direction, the reverse flux may be measured.
Upper Limit Alarm	The flux is larger than the upper limit of setting value.
Lower Limit Alarm	The flux is smaller than the lower limit of setting value.
Function of Damping	The scope may be set from 0.2 second to 100 seconds (63% response time)

How to Choose A Right Model

The flowmeter model selection is very important in the application of instrument. The related information shows that in the practical application of instrument, 2/3 failures are caused by incorrect selection of model and incorrect installation of instrument to which the special attention shall be paid.

1. Data Collection

- ① Name of measured liquid and its chemical substance;
- ② Maximum flux and minimum flux, normal flux;
- ③ Maximum working pressure;
- ④ Maximum and minimum temperatures.

2. The measured liquid shall have certain conductivity, with conductivity $\geq 5\mu\text{S/cm}$

3. The maximum flux and the minimum flux shall meet the values specified in the following page.

4. The actual maximum working pressure shall be less than the rated working pressure of the flowmeter.

5. The maximum and minimum working temperatures shall meet the temperature requirement stipulated for flowmeter.

6. Whether negative pressure exists or not shall be confirmed.

You may choose a corresponding electromagnetic flowmeter according to the fluxes in the above table, and if the inside diameter of the selected electromagnetic flowmeter is different from that of the tube under existing process, the tube reduction or expansion shall be considered.

- 1. In case of tube reduction, whether the pressure loss caused by tube reduction will affect the process flow or not shall be considered.
- 2. If the price of product is considered, the electromagnetic flowmeter with smaller diameter may be selected to reduce investment relatively.
- 3. When the uncontaminated water is measured, the economic velocity is 2-3m/s, and when the solution which is easy to crystallize is measured, the velocity shall be increased appropriately to common velocity of no less than 2 m/s, so as to prevent the electrode of electromagnetic flowmeter from being covered.

Range of Measurable Flux

International Unit (Caliber: mm, Flux: m³/h)

Aperture (mm)	Minimum Range Velocity (0.1m/s)	Maximum Range Velocity (10m/s)
10	0.0283	2.8274
15	0.0636	6.3615
20	0.1131	11.3094
25	0.1767	17.6709
32	0.2895	28.9521
40	0.4524	45.2376
50	0.7068	70.6838
65	1.1946	119.4555
80	1.8095	180.9504
100	2.8274	282.7350
125	4.4177	441.7734
150	6.3615	636.1538
200	11.3094	1130.9400
250	17.6709	1767.0938
300	25.4462	2544.6150
350	34.6350	3463.5038
400	45.2376	4523.7600
500	70.6838	7068.3750
600	101.7846	10178.4600
700	138.5402	13854.0150
800	180.9504	18095.0400
900	229.0154	22901.5350
1000	282.7350	28273.5000
1100	1026.3281	34210.9350
1200	1221.4152	40713.8400
1400	1662.4818	55416.0600
1500	1908.4613	63615.3750
1600	2171.4048	72380.1600
1800	2748.1842	91606.1400
2000	3392.8200	113094.0000
2200	4105.3122	136843.7400
2400	4885.6608	162855.3600
2600	5733.8658	191128.8600

Instructions to Wiring

The following suggestions should be followed in wiring:

- (1) To protect the insulation within the terminal box of the sensor from being hit by humidity, it is suggested not to connect cables outdoor in rain.
- (2) Circular lug plate should be wrapped around both ends of power cable and signal wire.
- (3) Conduit tube is recommended. The tube can be thick and solid steel pipe or flexible metal pipe.
- (4) All main cable and signal cables of non-four-core 24V DC must be sleeved in steel conduit tube.
- (5) When there are waterproof sealing plugs, the sealing plug should be fastened to prevent the box from leaking.

To protect the operators and the maintenance personnel from electric shock and shield external noises, the earthing wire should be connected to the sign \oplus ($\leq 10\Omega$).

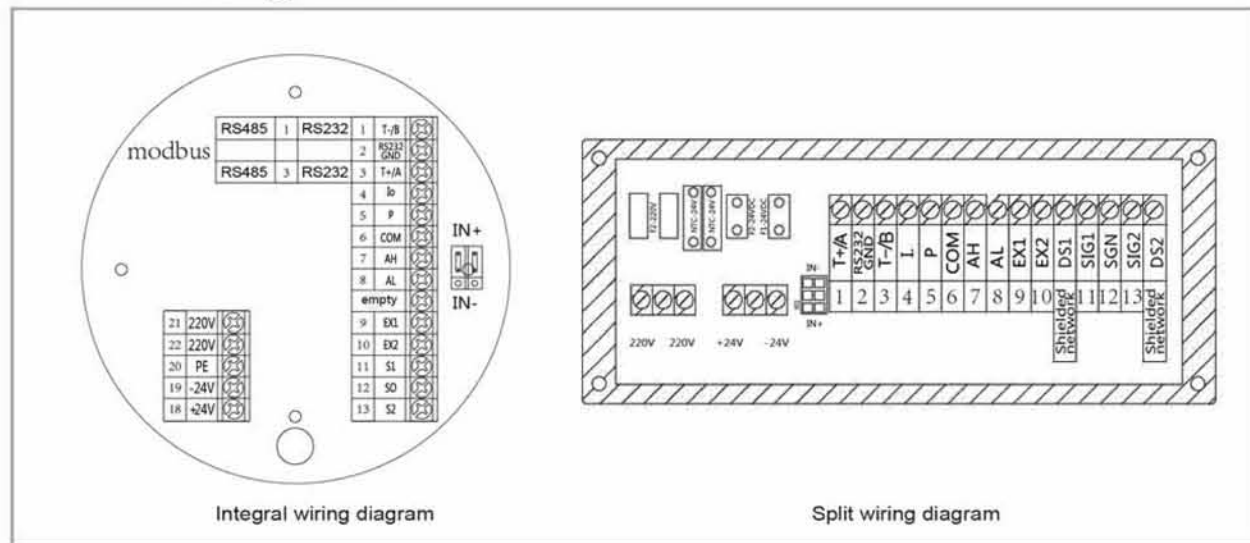

Symbol description of terminal

Terminal Symbol	Function specification	Terminal Symbol	Function specification
1 T-/B	RS485 Communication output	1 T+/A	RS485 Communication output
2 RS232 GND		2 RS232 GND	
3 T+/A		3 T-/B	
4 I/O	4-20mA current output	4 I/O	4-20mA current output
5 P	Bi-directional flux pulse output/frequency output	5 P	Bi-directional flux pulse output/frequency output
6 COM	Alarm output for upper limit of flux	6 COM	Alarm output for upper limit of flux
7 AH		7 AH	
8 AL		8 AL	
empty	Excitation current	9 EX1	Excitation current
9 EX1		10 EX2	
10 EX2		Shielded network DS1	
11 S1	Electrode wire	11 S1G1	Electrode wire
12 S0	Earthing wire	12 SGN	Earthing wire
13 S2	Electrode wire	13 S1G2	Electrode wire
21 220V	AC power supply access point	Shielded network DS2	AC power supply access point
22 220V		220V	
20 PE		220V	
19 -24V	24V power supply access point	-24V	24V power supply access point
18 +24V		+24V	

The flux output will turn out to be positive when the short circuit piece is connected to (P+) above, while negative for (P+) below.

Display and Setup Instruction of Electromagnetic Flowmeter in Working Condition

Three lines displayed in working condition:

Upper line:

Instantaneous flux 36.234m³/h, the "+" and "-" in front of the figures refer to the forward or reverse direction of the flow.

Top right corner: If the instrument alarms, the alarm bell will be revealed on the top right corner. In normal working conditions, the battery meter band will be displayed.

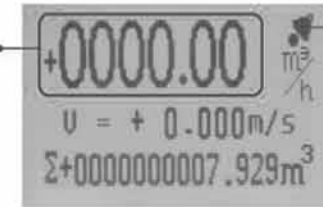

1. Ratio: +072.8%. This item shows the percentage within the measurement range during the running

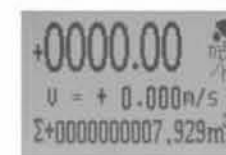

2. Velocity: +07.286 m/s. The speed of the medium flowing through the flowmeter.



3. Resistance: 0009.8 KΩ. The resistance of the medium flowing through the flowmeter.



4. Σ+00000002495.886m³. Accumulative amount of forward direction flux



5. Σ-0000000005.886 m³. Accumulative amount of reverse direction flux

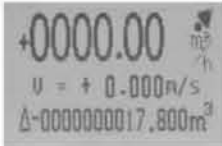

6. $\Delta \pm 00000002490.000 \text{ m}^3$. The accumulative amount of both forward and reverse direction flux



7. Normal excitation/excitation alarm
Normal excitation/abnormal field coil or related parts

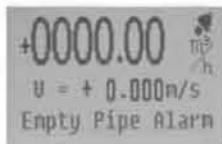

8. Normal Hollow conduit/Hollow conduit alarm
Fluid inside the conduit satisfying measuring requirements/No medium to be measured inside the conduit or the medium does not fill the conduit or has insufficient conductivity

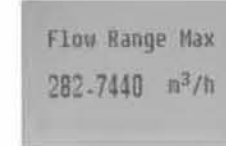

2. Setup of instrument range

- Press **SET** to enter the Setting Interface.
- With reference to the keystroke instruction, modify the numerical value to your desired value; the figure refers to the upper limit flux of the flowmeter. This setup will not influence the measuring value of the flowmeter, but it will become the basis for the current output of the flowmeter and frequency (pulse) output.
- Press **ESC** to exit the Setting Interface.
- Press **▲** or **▼** to choose the former or the next item. Here **▼** can be pressed to choose item 4 below.

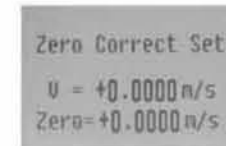

3. Set the zero point of flux manually

- This value is used for calibration before leaving the factory, not allowed to be modified by users.
- Press **SET** to enter the Setting Interface.
- The conduit must be fully packed and the fluid inside the conduit must be static before setting the above value. Set and adjust the value until the benchmark figure points at zero according to the button specification.
- Press **ESC** to exit the Setting Interface.
- Press **▲** or **▼** to choose the former or the next item. Here **▲** can be pressed to choose item 5 below.



4. Measure damping time

- Press **ESC** to exit the Setting Interface.
- Press **ESC** to exit the Language Setting Interface.
- Press **▲** or **▼** to choose from 0.2S, 0.5S, 0.8S, 1S,..... 100S, An increased damping time may increase the flux of the meter and improve the stability of the output signal. When there is pulse output within the meter, the interval of pulse should be less than the damping time.
- Press **▲** or **▼** to choose the former or the next item. Here **▲** can be pressed to choose item 6 below.

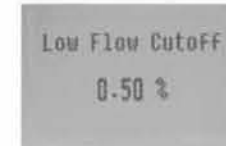

5. Dwarf signal removal point

- Press **SET** to enter the Setting Interface.
- With reference to the keystroke instruction, modify the numerical value to your desired value; the figure is set when the flowmeter is slightly disturbed and the removed part is the percentage of the measuring range value. All instantaneous fluxes below this figure will come down to zero and will not be accumulated.
- Press **ESC** to exit the Setting Interface.
- Press **▲** or **▼** to choose the former or the next item. Here **▲** can be pressed to choose item 7 below.

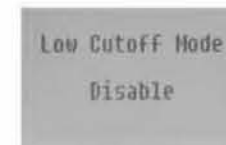

6. Method for removing dwarf signal

- Press **SET** to enter the Setting Interface.
- Press **▲** or **▼** to choose between Permit and Prohibit. If prohibit is chosen, the setup for dwarf signal removal point will be invalid.
- Press **ESC** to exit the Setting Interface.
- Press **▲** or **▼** to choose the former or the next item. Here **▲** can be pressed to choose item 8 below.

Menus and Buttons for Setting the Parameters of Electromagnetic Flowmeter

Introductions to keys and key combinations

- **Report** key
- **Displacement** key
- **Page down** key, used to display numbers from 9 to 0 in order when the key is used
- **Page up** key, used to display numbers from 0 to 9 in order when the key is used
- **OK** key equals to the Enter key. It is used to enter or exit menu for modification.
- **+ (SET)** Used for access to Setup Menu

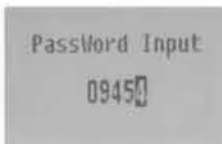

Enter password Setting Interface by pressing **SET** and **ESC** 09454 is the password to the Setup Menu. Change the 4 random figures displayed into 09454 and then press **SET** to enter Setup Menu

The content of menu and specification

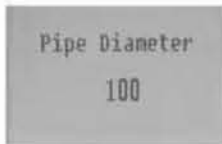

1. Choose the aperture of measuring pipe

- Press **SET** to enter the Setting Interface.
- Press **▲** or **▼** to choose the aperture actually needed from 3, 6, 8, 10, 15, 20, 25, 32, 40, 50, 65, 80, 100, ... 3200.
- Press **ESC** to exit the Setting Interface.
- Press **▲** or **▼** to choose the former or the next item. Here **▼** can be pressed to choose item 3 below

Flow Direction
Forward

7. Choose directions of the flux

- Press **SET** to enter the Setting Interface.
- Press **▲** or **▼** to choose between "Forward" and "Reverse", which will change the directions of the flux to either forward or reverse direction.
- Press **SET** to exit the Setting Interface.
- Press **▲** or **▼** to choose the former or the next item. Here **▲** can be pressed to choose item 9 below.

Reverse Measure
Enable

8. Reverse measure permission

- Press **SET** to enter the Setting Interface.
- Press **▲** or **▼** to choose between Permit and Prohibit. If prohibit is chosen, the reverse flux will not be revealed and accumulated.
- Press **SET** to exit the Setting Interface.
- Press **▲** or **▼** to choose the former or the next item. Here **▲** can be pressed to choose item 10 below

PulseOutput Mode
Frequency

9. Frequency pulse output mode

- Press **SET** to enter the Setting Interface.
- Press **▲** or **▼** to choose between two modes of current output: Frequency and Pulse.
- There are two modes of pulse output: pulse output and frequency output. Pulse output is a pulse train of rectangular wave where one pulse will be delivered when the instantaneous flux amounts to one equivalent of pulse. While frequency output is successive square wave where the value of the output frequency and the instantaneous flux are associated with the preset upper limits of the flux and frequency and the upper limit of frequency corresponds to the set value of range.
- Press **SET** to exit the Setting Interface.
- Press **▲** or **▼** to choose the former or the next item. Here **▲** can be pressed to choose item 12 below.

Frequency Range
1000 Hz

10. Range of frequency output

- Press **SET** to enter the Setting Interface.
- With reference to the keystroke instruction, modify the numerical value to your desired value. The choosing of frequency output range becomes valid only when you choose the frequency output. This figure refers to the frequency output when the instantaneous flux reaches the preset upper limits.
- Press **SET** to exit the Setting Interface.
- Press **▲** or **▼** to choose the former or the next item. Here **▲** can be pressed to choose item 15 below.

Unit Totalizer
0.001m³

11. Units of integrated flux

- Press **SET** to enter the Setting Interface.
- Press **▲** or **▼** to choose: 1L, 0.1L, 0.01L, 0.001L; 1 m³, 0.1 m³, 0.01 m³, 0.001 m³; 1KG, 0.1KG, 0.01KG, 0.001KG; 1T, 0.1T, 0.01T, 0.001T. The setting may change the decimal point and unit of integrated flux. At the same time, the unit of instantaneous flux will change with the unit of integrated flux.
- Press **SET** to exit the Setting Interface.
- Press **▲** or **▼** to choose the former or the next item. Here **▲** can be pressed to choose item 16 below.

COM Address
01

12. Instrument communication address

- Press **SET** to enter the Setting Interface.
- With reference to the keystroke instruction, modify the numerical value to your desired value. The set value of this item is a 4-bit code address used for instrument centralized controlling communication.
- Press **SET** to exit the Setting Interface.
- Press **▲** or **▼** to choose the former or the next item. Here **▲** can be pressed to choose item 24 below.

COM Baud Rate
9600

13. Instrument communication speed

- Press **SET** to enter the Setting Interface.
- Press **▲** or **▼** to select: 600, 1200, 2400, 4800, 9600, 14400. The value is to select appropriate rate according to the situation of communication signal receiver.
- Press **SET** to exit the Setting Interface.
- Press **▲** or **▼** to choose the former or the next item. Here **▲** can be pressed .

Sensor Factor
1.0000

14. Sensor coefficient:

- Press **SET** to enter the Setting Interface.
- With reference to the keystroke instruction, modify the numerical value to your desired value. This set value is used for setting sensor flux coefficient. See instrument nameplate.
- Press **SET** to exit the Setting Interface.
- Press **▲** or **▼** to choose the former or the next item. Here **▲** can be pressed.

Converter Factor
1.3842

15. Converter coefficient

- This value is the calibration value of the converter used for factory calibration, not allowed for modification by users.
- Press **▲** or **▼** to choose the former or the next item. Here **▲** can be pressed .

Sensor SN.
000000000000

16. Instrument calibration coefficient

- Press **SET** to enter the Setting Interface.
- With reference to the keystroke instruction, modify the numerical value to your desired value. This value shows a calibration value of the instrument, and the instrument default is 1.
- Press **SET** to exit the Setting Interface.
- Press **▲** or **▼** to choose the former or the next item. Here **▲** can be pressed to choose item 30 below.

Converter SN.
000000000000

17. Converter codes

- Instrument internal parameter must not be modified.
- Press **▲** or **▼** to choose the former or the next item. Here **▲** can be pressed to choose item 41 below.

Flowmeter Model Description

Name	Specification code	Description
Instrument type	LDG	Intelligent electromagnetic flowmeter
Measured pipe diameter	xxx	For example: 100 represents DN100
Electrode form	1	Standard stationary type
Electrode material	0	Stainless steel (316L)
	1	Platinum Pt
	2	Hastelloy B (HB)
	3	Tantalum Ta
	4	Titanium Ti
Lining material	5	Hastelloy C (HC)
	3	Chloroprene rubber
	4	Polyurethane rubber
Rated pressure	5	F4 (PTEE) polyfluortetraethylene
	6	F46 (FEP) polyperfluoroethylene-propylene
	4.0	DN10-80
Working temperature of medium	1.6	DN100-150
	1.0	DN200-1000
	0.6	DN1100-2000
Grounding	0.25	DN2200
	E	<60°C
Grade of protection	H	<120°C
	1	Built-in grounding electrode
Converter type	0	IP65
	1	IP68
Case material	0	Integral type
	1	Split type
Instrument flange material	-0	Carbon steel
	1	Stainless steel
Installing timing flange	0	Carbon steel
	1	Stainless steel
Power supply source	0	Without
	1	With
Instrument range	0	220VAC
	1	24VDC
Instrument range	(xxx)	For example: (200) represents maximum flux corresponding to 20mA

For example: 100-1 03-1 .6E00-0010

Note: Intelligent electromagnetic flowmeter DN100 has a fixed stainless steel electrode and chloroprene rubber lining, with a rated pressure of 1.6 Mpa, a temperature less than or equal to 60 degrees centigrade and protection grade of IP65. It is of integral type. Case material and flange are made from carbon steel, with mounting companion flanges (including bolt and nut). It is powered by 220V AC power supply.

Outline Dimension of Integral Flowmeter:

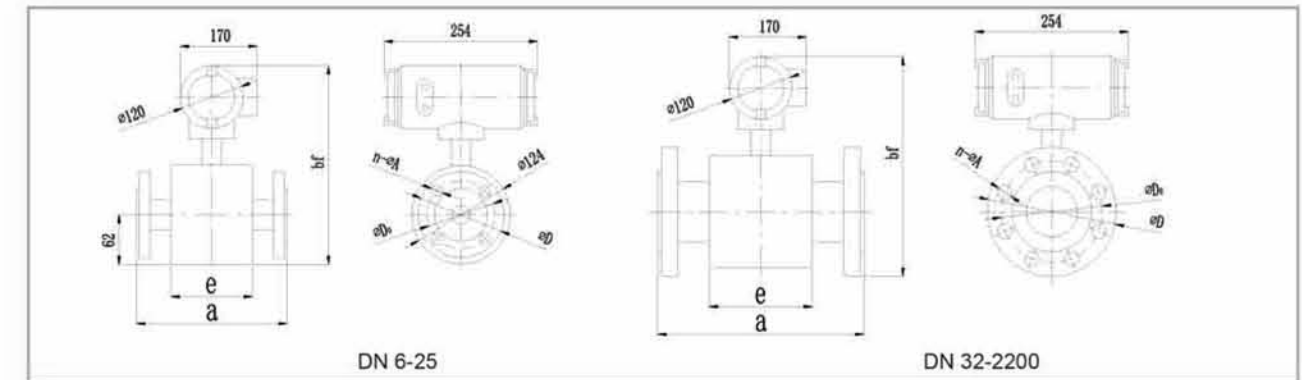

DN	Rated pressure (MPa)	Instrument outline dimension (mm)			Flange connection size (mm)		
		a	bf	c	D	D ₀	n × A
6	4.0	102	252	62	76	58	4-Φ7
10		150	322	82	90	60	4-Φ14
15		150	322	82	95	65	4-Φ14
20		150	322	78	105	75	4-Φ14
25		150	312	78	115	85	4-Φ14
32		150	327	74	135	100	4-Φ18
40		150	335	74	145	110	4-Φ18
50		200	354	86	160	125	4-Φ18
65		200	366	92	180	145	8-Φ18
80		200	385	92	195	160	8-Φ18
100	1.6	250	406	114	215	180	8-Φ18
125		250	436	114	245	210	8-Φ18
150		300	465	136	280	240	8-Φ23
200	1.0	350	518	156	335	295	8-Φ23
250		400	570	202	390	350	12-Φ23
300		500	620	230	440	400	12-Φ23
350		500	675	278	500	460	16-Φ23
400		600	733	320	565	515	16-Φ25
450		600	782	374	615	565	20-Φ25
500		600	835	388	670	620	20-Φ25
600		600	940	408	780	725	20-Φ30
700		700	1048	520	895	840	24-Φ30
800		800	1160	580	1010	950	24-Φ34
900	0.6	900	1260	660	1110	1050	28-Φ34
1000		1000	1370	720	1220	1160	28-Φ34
1200		1200	1585	1130	1405	1340	32-Φ34
1400		1400	1810	1260	1630	1560	36-Φ36
1600		1600	2040	1450	1830	1760	40-Φ36
1800		1800	2250	1640	2045	1970	44-Φ39
2000	2000	2460	1820	2265	2180	48-Φ42	

The model selection of the electromagnetic flowmeter is preferably performed by a technician who is familiar with on-site technological conditions. The technician shall select proper aperture, lining material and electrode and so on according to the measurable range table in the type selection material, and the selection is preferably confirmed by an end user who is familiar with the on-site technological conditions.

Selecting flowmeter type

● Integral type and split type

Both integral type and split type have their own advantages, and basic principals for selection are as follows: the split type is usually used in situations inconvenient for one-site maintenance and numerical reading when commissioning is difficult or the flowmeter is often immersed in water and with other functions. It is also used in poor application situations, such as high temperature fluid, a position with vibration source and explosive environment. In most cases, both the integral type and the split type can meet use requirements.

● General type and explosion-proof type

Users shall confirm to select a general type or an explosion-proof type according to application environment of the flowmeter.

The diameter of the sensor and that of technological pipeline.

Generally, it's suggested not to select reducing pipe for the sake of convenient installation, provided that the flux used in the flowmeter pipe shall be within the range of 0.3m/s-10m/s. This kind of selection is usually applicable to a newly-designed project for which not only current working conditions are considered when choosing a velocity, but also a situation of running at full load of the device in the future shall be considered. For the relationships among the flux, velocity and diameter, see curve graph. However, sometimes we also choose a sensor with a different diameter with the connected technological pipeline diameter, for example:

1. The velocity in the pipeline is low and the process flux is stable. In order to meet the demand of instrument for flux range and improve local velocity of the flowmeter, select a sensor with smaller diameter than the technological pipeline and additionally connect a reducing pipe at front and rear part of the sensor.
2. In terms of large diameter electromagnetic flowmeter, the larger the diameter is, the higher the price will be. As for the situations with low velocity in the pipeline and stable technological parameter, small diameter flowmeter may be chosen. This not only runs the flowmeter under good working state, but also reduces investment cost.

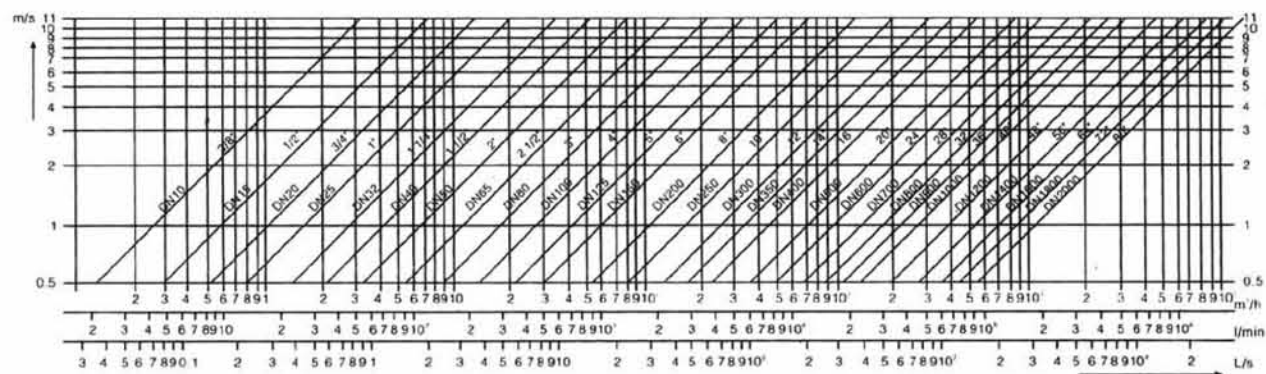

Curve Chart of the Relationships among the Diameter Velocity and Flux of Flowmeter

Length of Straight Pipe Segment

To guarantee the upstream pipeline condition required for achieving high measurement precision of electromagnetic flowmeter, pipeline condition as shown in following figure are recommended according to standards above and measured data of pipeline condition.

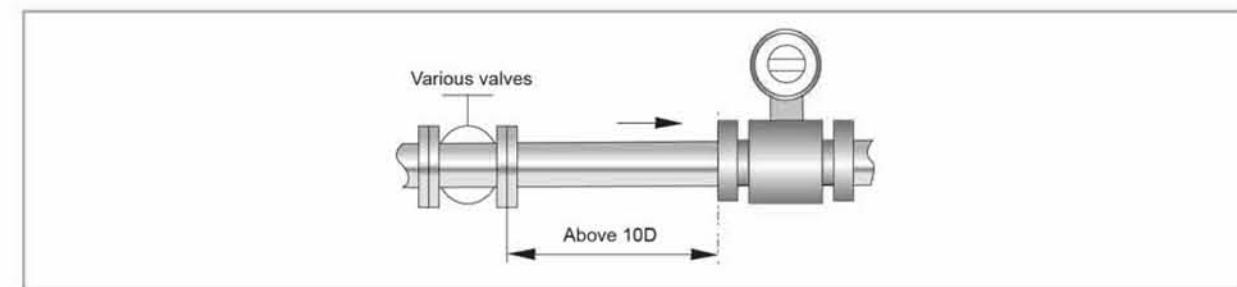
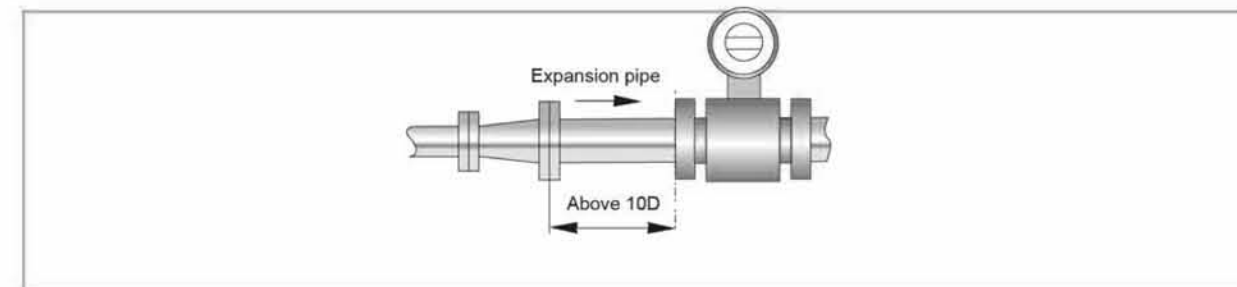
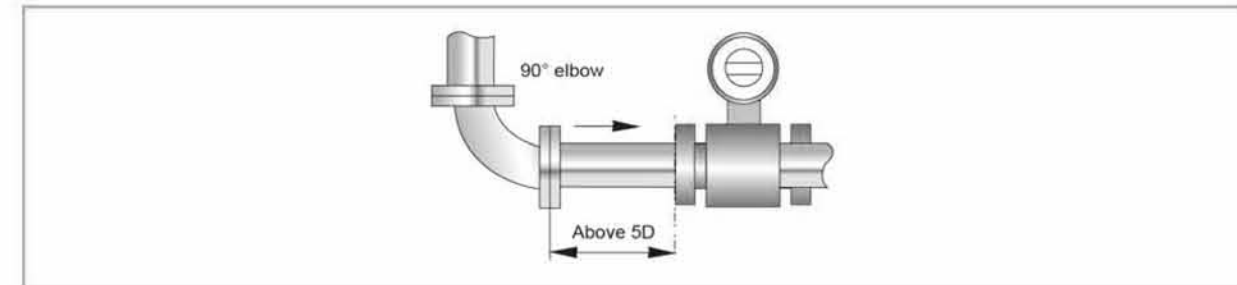
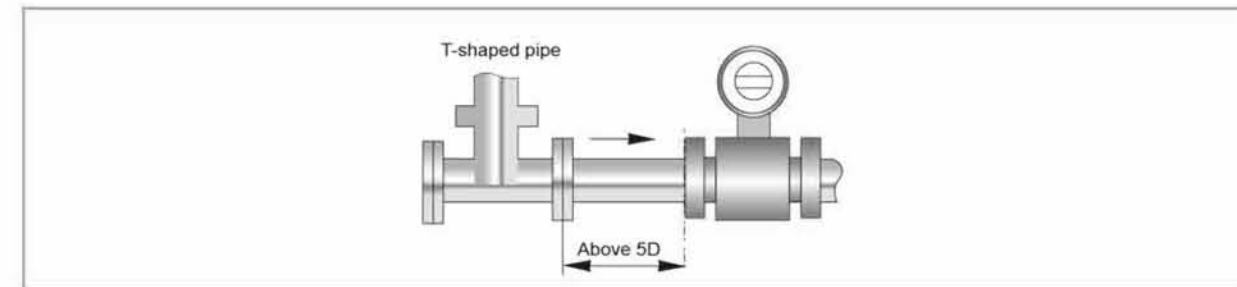
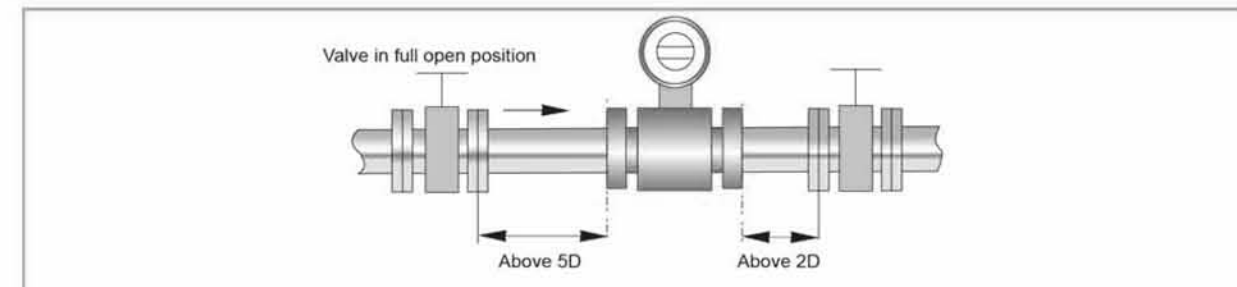

Minimum Length of Required Straight Pipe Segment

Notes for Additionally Installing a Reducing Pipe

For not mapping distribution of flux field after installing the reducing pipe and not influencing precision of the electromagnetic flowmeter, the reducing pipe can be regarded as a part of the straight pipe segment. The central cone angle α of the reducing pipe shall be no more than 150 degrees, and the smaller the better.

● **Installing a reducing pipe will cause pressure loss**

Total pressure loss composes three parts:

- (1) Pressure loss in reducing pipe $\Delta P1 = \rho/2\xi1V2^2$
- (2) Pressure loss in increasing pipe $\Delta P3 = \rho/2\xi3V2^2$
- (3) Pressure loss in sensor measuring pipe $\Delta P2 = \rho/2\xi2V2^2$

The total pressure loss is:

$$\Delta P = 0.01 (\Delta P1 + \Delta P2 + \Delta P3) \text{ (mbar)}$$

Where, ρ is medium density in kg/m^3

$\xi1, \xi3$ are respectively coefficients related with the Reynolds number of reducing pipe and increasing pipe

$\xi2 = 0.02$ is a coefficient of sensor measuring pipe

$V1$ and $V2$ are respectively velocities in the technological pipeline and sensor measuring pipe, whose unit is m/s

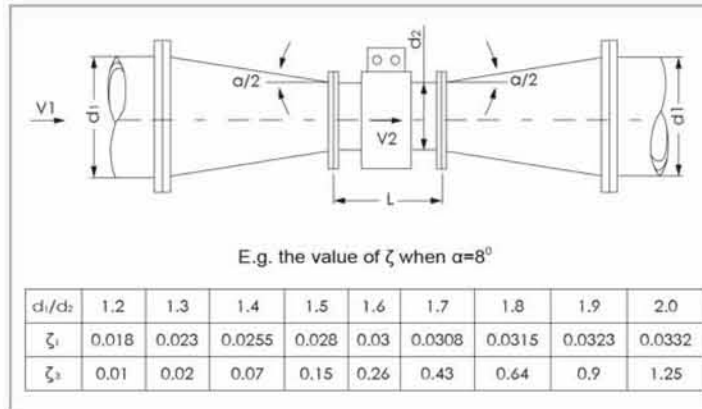

Installation Direction

When installing an electromagnetic flowmeter, generally speaking, the axis of the electrode shall be approximately level in horizontal installation. If the axis of the electrode is perpendicular to the ground, bubbles will be easily collected near the electrode located on the upper side, while the electrode located at lower side and stopping the liquid contacting with the same is covered by slurry. The converter shall be installed above the pipeline to prevent water from entering the converter.

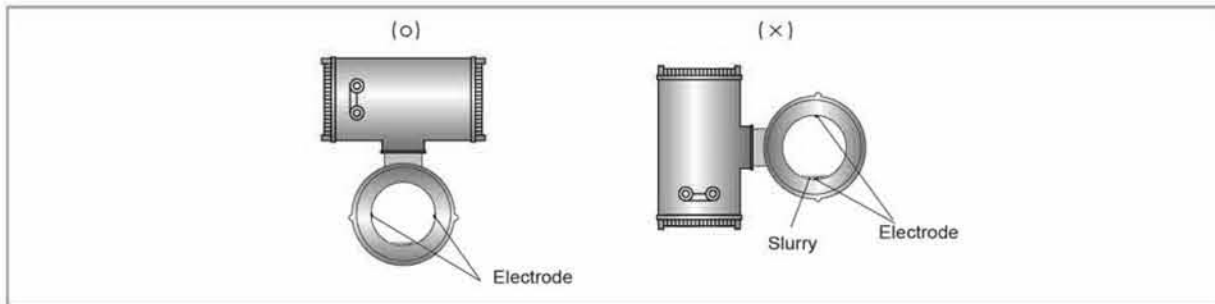

Reducing Pipe

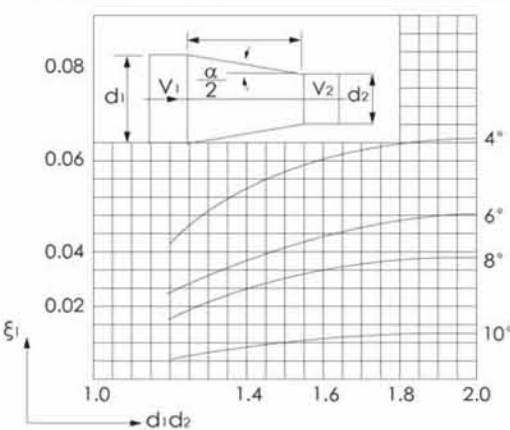

Increasing Pipe

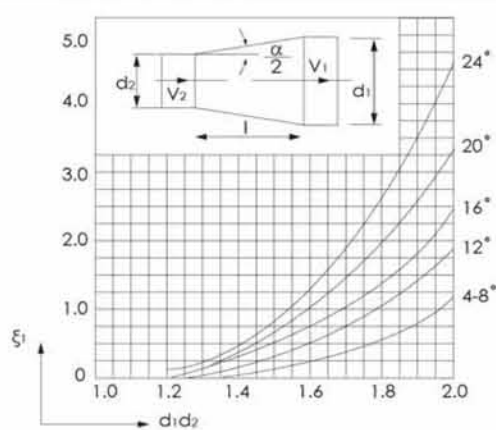

Electromagnetic flowmeter must work in full pipe conditions, that is to say, the flowmeter cannot normally work in partially filled pipe or empty pipe conditions.

The positive direction in which fluid flows is generally in the same direction as the arrows in the sensor. There must be an enough installation and maintenance space close to the flowmeter to prevent the flowmeter from being vibrated. During installation of the flowmeter, supports for supporting pipelines should be provided on the two sides of the flowmeter. Stress is prevented from being affected because of pipeline vibration, impact and shrinkage. For heavily polluted fluid, a consideration that a flowmeter is installed on the pipeline should be given.

Flowmeter Piping

Misalignment or inclination of pipeline is a reason why the pipeline flange bounces and breaks.

(1) During installation of flowmeter, misalignment or inclination of pipeline, and installation distance deviation between two flanges should be corrected first.

(2) During installation of flowmeter, generally there are some foreign matters (e.g., welding slag and scraps) within pipeline path. Prior to installing the flowmeter, these impurities should be washed away.

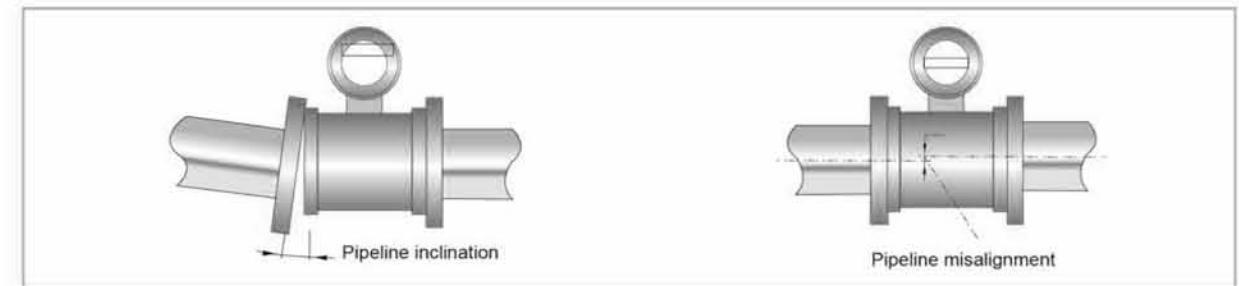

Conductivity of Fluids

Electromagnetic flowmeter cannot be installed where the conductivity of fluids is very uneven. In particular when chemicals are injected from the upstream of the instrument, it is very easy to cause unevenness of conductivity, thereby seriously interfering the measurement of flowmeter. In this case, we recommend that chemicals should be injected from the downstream of the instrument. If chemicals must be injected from the upstream of the instrument, a straight pipe segment which is long enough must be installed to ensure that fluids are mixed well.

Liquid Sealant

The following points should be mentioned during using fluid sealant: Don't let it cover the surfaces of electrode and grounding ring because this will influence the measurement of flux.

Adopting Throttle Valves and Bypass Valves

For convenient maintenance and zero setting, throttle valves and bypass valves are suggested to adopt. Ensuring no bubble in flowmeter! Pipeline design should ensure that no bubble can be separated from fluid. Generally, the flowmeter should be installed on the upstream of the valve, because the pressure in the pipeline is reduced under the action of the valve, thereby producing bubble.

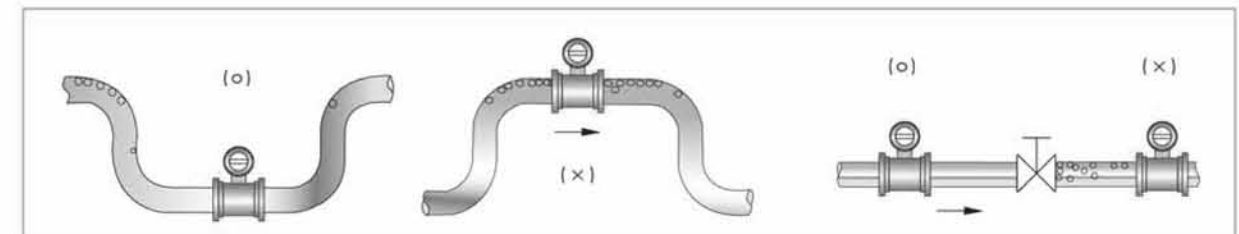

Selection of Electrode Materials

Electrode materials should be selected according to the corrosivity of measured medium, and selected by users familiar with site conditions. In general, the corrosion resistance of electrode material is higher than that of pipeline material by one grade. For ordinary media, please consult related anti-corrosion manuals. For media having complex components such as mixed acid, coupon tests should be done.

Properties of Electrode Material (for reference only)

Electrode material	Properties of measured material (for reference only)	Corrosion resistance
316L	Domestic water, industrial water, raw well water, urban sewage, weak corrosive acid, alkali, salt solutions	
Hastelloy alloy B(HB)	Hydrochloric acid (concentration less than 10%), and other non-oxidizing acids Sodium hydroxide (concentration less than 50%), all concentrations of alkali-ammonium hydroxide solution Phosphoric acid, organic acids	Not apply to nitric acid
Hastelloy alloy C(HC)	Mixed acids such as chromic acid and sulfuric acid solution Oxidizing salts such as Fe ⁺⁺⁺ , Cu ⁺⁺ , water	Not apply to hydrochloric acid
Titanium	Salts, such as: (1)chloride(ammonium oxide / calcium/magnesium / Aluminum/iron/etc) (2) the sodium salt, potassium salt and ammonium salt and sodium hypochlorite salts, as well as potassium hydroxide, ammonium hydroxide, barium hydroxide caustic soda solution with sea water concentrations less than 50%	Not apply to hydrochloric acid, sulfuric acid, phosphoric acid, hydrofluoric acid and other reducing acid
Tantalum	Hydrochloric acid (concentration less than 40%), dilute sulfuric acid and concentrated sulfuric acid (not including oleum) Chlorine dioxide, ferric chloride, hypochlorite, sodium hydroxide, lead acetate Nitric acid (including fuming nitric acid) and other oxidizing acid, aqua regia with temperature below 80 degrees centigrade	Not apply to alkali and hydrofluoric acid
Platinum	Almost all of the acid, alkali, salt solutions (including fuming sulfuric acid, fuming nitric acid)	Not apply to aqua regia, ammonium salt
Tungsten Carbide	Pulp, sewage, solid particles with anti-interference property	Not apply to inorganic acids, organic acids, chlorides

Selection of Grounding Ring Material

Grounding ring material can be the same as the electrode material. Generally material with the same corrosion resistance as the pipeline material is selectable.

Selection of Lining Material

Lining material should be selected according to the type and working temperature of measured fluid. PFA is a kind of fluorinated plastic, with good corrosion resistance to strong acid and alkali. It can withstand high temperature, with no deformation and reduction in insulation resistance at high temperature. 99.9% high purity alumina is used for making ceramic lining so that the instrument can measure the flux with high precision. In comparison with traditional high polymer material, ceramics cannot create high temperature, high pressure deformation, and have good wear resistance.

Advantages of polytetrafluoroethylene (PTFE)

- High temperature resistance - working temperature is up to 120°C.
- Low temperature resistance- good mechanical toughness; even if the temperature drops to -196°C, it still can maintain elongation of 5%.
- Corrosion resistance-for many chemicals and solvents, it presents inertness and is resistant to strong acid, strong alkali, water and various organic solvent.
- Weather resistance – boasting the best ageing lifetime in plastics.
- High lubrication - boasting the lowest coefficient of friction in solid materials.
- Non-adhesive - boasting the lowest surface tension in solid materials and not adhering to any substances.
- Nonhazardous - have physiological inertness and can be implanted in human bodies for a long term as blood vessel prosthesis and visceral organ, with no adverse reactions.

Advantages of F46

- Like PTFE, F46 has good corrosion resistance, but has a higher temperature resistance than PTFE, up to 160°C. It can be used for sanitary products and jetted molding, and is easier to be processed.

Advantages of polyurethane rubber

- With code name UR, it is polymerized from polyester (or polyether) and diisocyanate compound. For the properties, it has the highest abrasive resistance in rubbers. Its advantages include: high strength and elasticity, good oil resistivity, ozone resistance, ageing resistance and good air tightness. The disadvantages include: poor wet resistance, water resistance, alkali resistance and solvent resistance. It is used in places requiring high abrasive resistance, high strength and oil resistance.

Advantages of chloroprene rubber

- It has good cohesiveness, softness and abrasion resistance, water resistance, ageing resistance and other characteristics. It has poor oil resistivity and is prone to aging corrosion in environment with mixed oil and gas.