

專業設計與製造 - 格瑞特魯氏鼓風機

Professional designer and manufacturing - Greatech Roots Blower



廣勝工業有限公司

GREATECH MACHINERY INDUSTRIAL CO., LTD.

地址：台南市永康區中正一路48號

Add: No. 48, Zhongheng 1 Str., Yongkang Dist.,
Tainan City 710, Taiwan

Tel: +886-6-2536997 (rep.)

Fax: +886-6-2533092 (rep.)

E-mail: greatech.rootsblower@hotmail.com

sales@greatech-rootsblower.com

Website: www.greatech-rootsblower.com

Edition: 2011.10

廣勝工業有限公司

Greatech Machinery Industrial Co., Ltd.

GREATECH ROOTS BLOWER

格瑞特魯氏鼓風機



卓越設計 技術創新

GREAT DESIGN TECHNICAL INNOVATION

節能減碳高效率 — 格瑞特魯氏鼓風機

ENERGY SAVING, CARBON REDUCTION AND
HIGH EFFICIENCY — GREATECH ROOTS BLOWER

性能

口徑: 25mm ~ 400mm (1" ~ 16")
風量: 0.1 ~ 280 m³/min (6 ~ 16800 m³/hr)
壓力: 單段式可達10000 mmAq
兩段式可達20000 mmAq
真空型可達 -5000 mmAq

特點

三葉魯氏鼓風機
節能省電、低噪音
風量穩定、低震動
結構堅固、壽命長
氣體乾淨、無油污

用途

廢水處理，水產養殖，電鍍，粉粒輸送，
穀類輸送，造紙工業，食品工業，
半導體工業，化學工業...等

Performance

Bore Size: 25mm ~ 400mm (1" ~ 16")
Capacity: 0.1 ~ 280 m³/min (6 ~ 16800 m³/hr)
Pressure: Single Section: 0~ 10000 mmAq
Two Section: 10000~20000 mmAq
As vacuum blower: up to -5000 mmAq

Advantage

Tri-Lobe Roots Blower
Energy Saving, Low Noise
Stable Air Volume, Extremely Low Vibration
Solid Construction, Long Operating Life
Clean air, No oily Odors

Application

Waste Water Treatment, Aquaculture,
Electroplating Industry, Powder Conveyance,
Grain Transport, Paper Making Industry,
Food Industry, Semiconductor Industry,
Chemical Industry...etc.

■ 構造圖及材質表

Construction & Material List

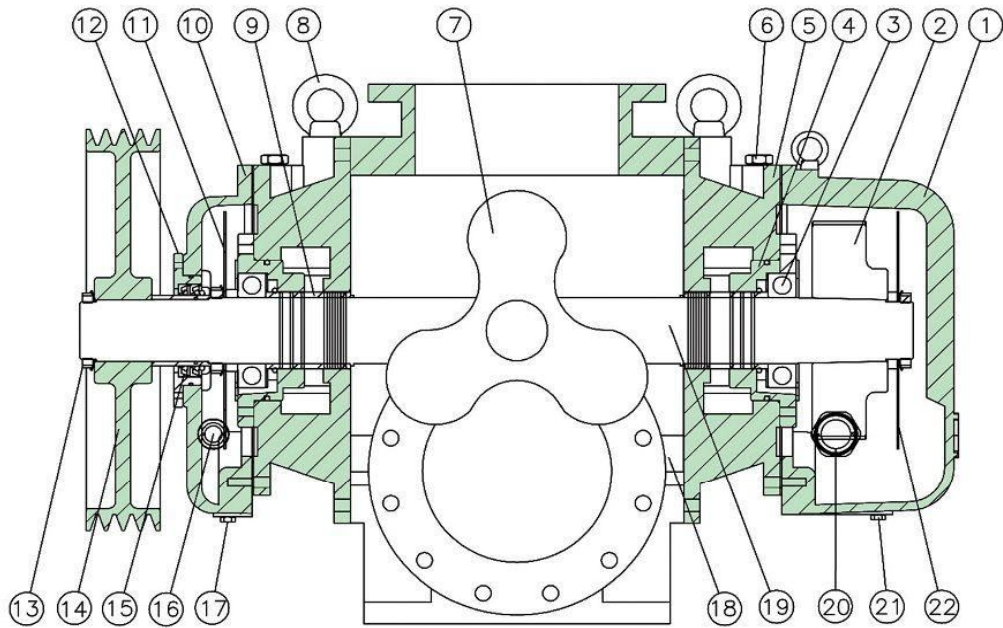

No.	Item	Material	No.	Item	Material
1	gear box 齒輪箱	FC250	12	oil seal case 油封座	FC250
2	gear 齒輪	SCM415	13	screw nut 螺帽	SS400
3	bearing 軸承	SUJ2	14	pulley 皮帶輪	FC250
4	bearing case 軸承座	FC250	15	oil seal 油封	NBR
5	side cover 側蓋	FC250	16	oil gauge 油鏡	S45C
6	oil plug 加油塞	S45C	17	oil drainer 洩油塞	S45C
7	Impeller 葉輪	FC250	18	cylinder 氣缸	FC250
8	eye bolt 吊環	S45C	19	shaft 軸	SCM440
9	shaft seal 軸封	S45C	20	oil gauge 油鏡	S45C
10	oil box 油箱	FC250	21	oil drainer 洩油塞	S45C
11	oil splash 甩油片	SS400	22	oil splash 甩油片	SS400

壓送型性能曲線

Pressure Conveyance Type Performance Curve

G32

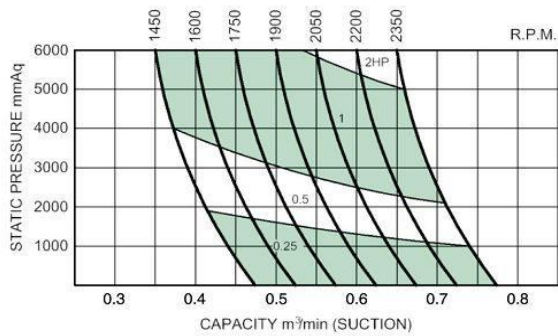

G50

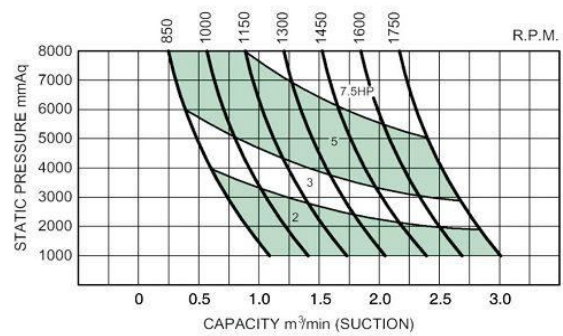

G40

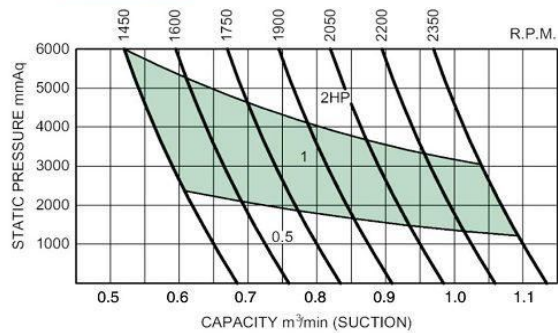

G65

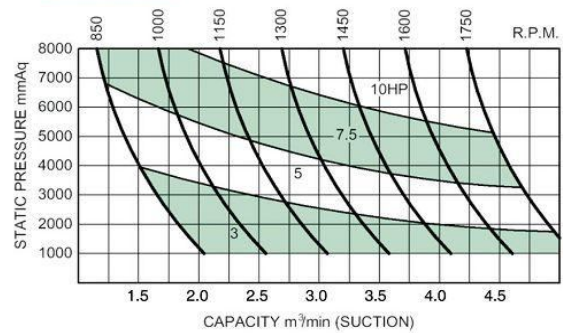

GL40

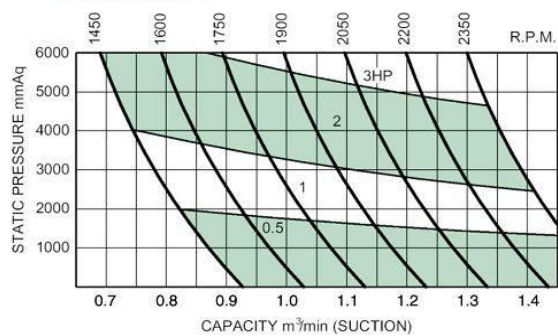

G80

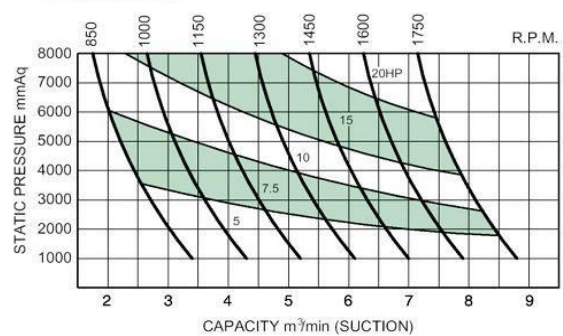

GREATECH ROOTS BLOWER

G100

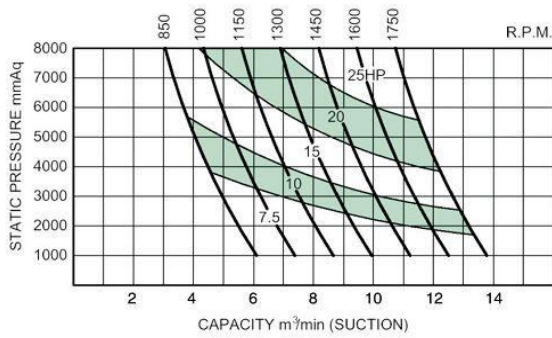

G200

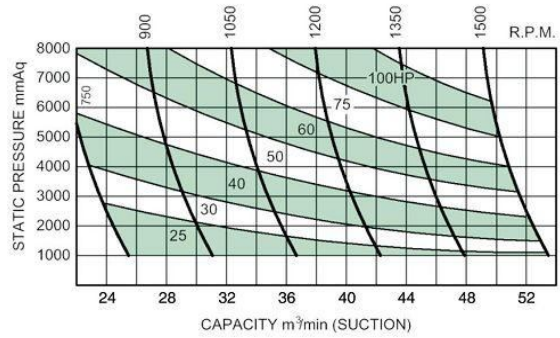

G125

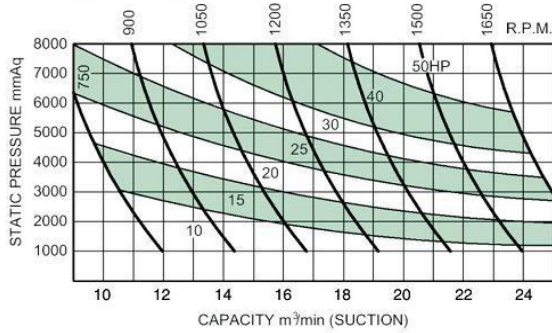

G250

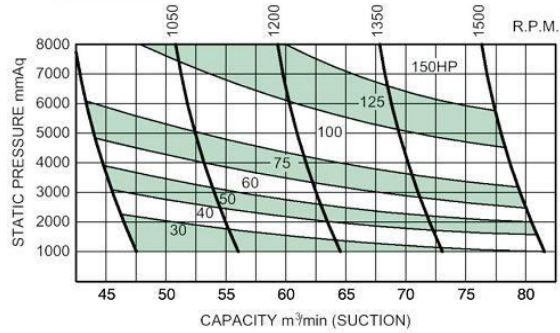

G150

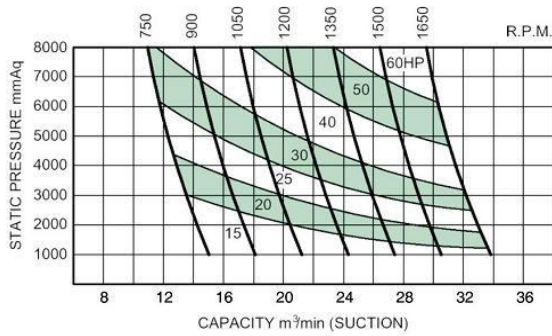

G300

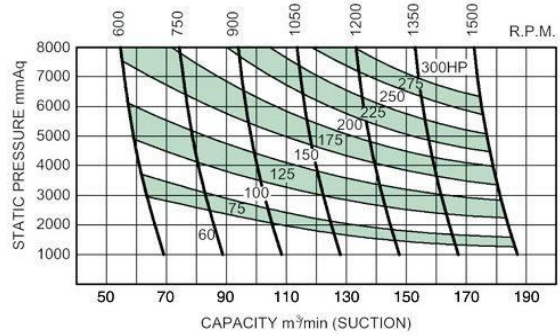

真空型性能曲線

Vacuum Type Performance Curve

G40V

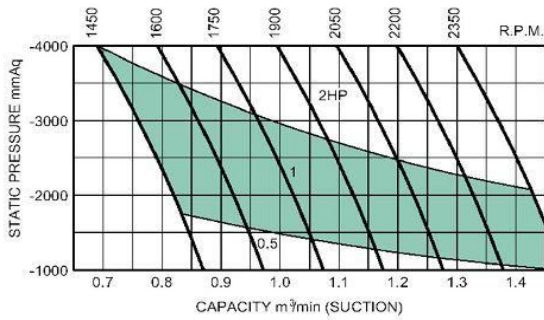

G80V

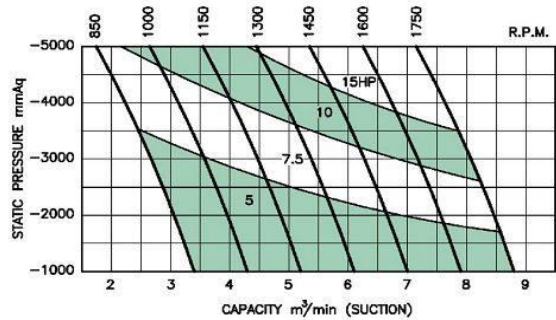

G50V

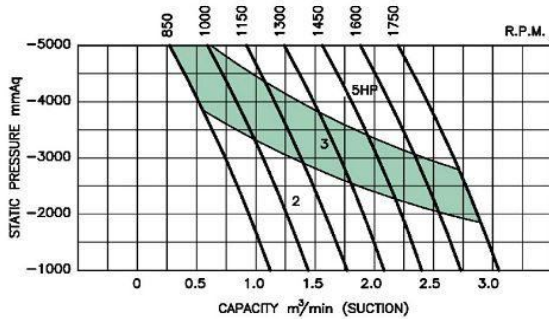

G100V

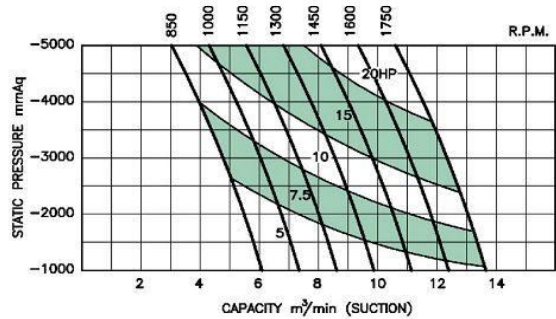

G65V

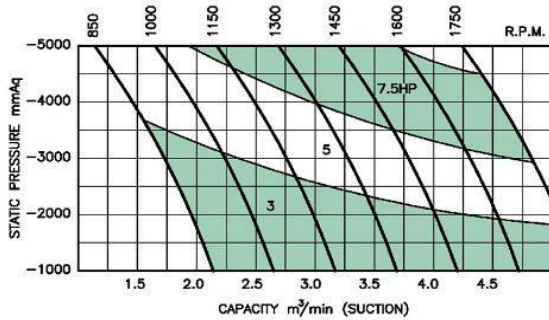

G125V

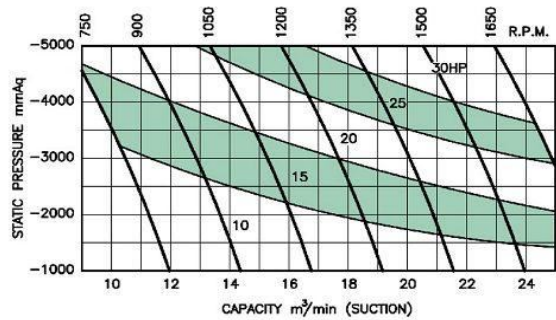

GREATECH ROOTS BLOWER

G 150V

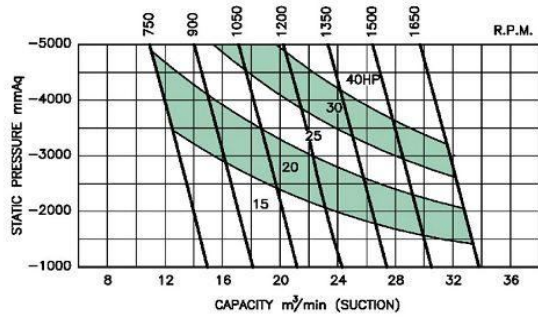

G 300V

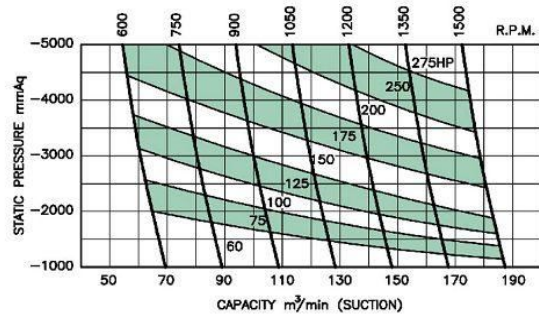

G 200V

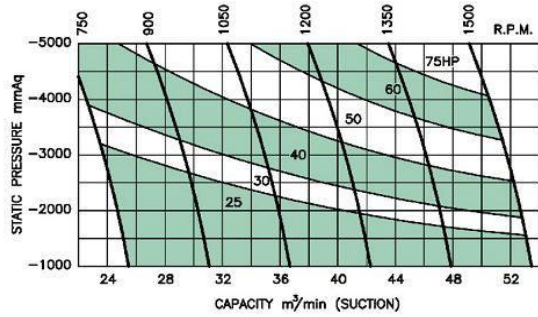

G 250V

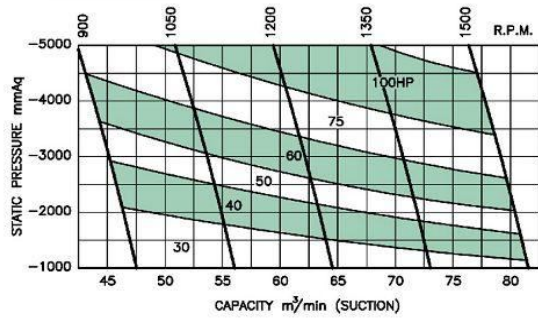

■ 壓送型性能表

Pressure Conveyance Type Performance Table

Model	RPM	Pressure(mmAq)				Capacity(m ³ /min)				Power(kW)							
		1000 mmAq		2000 mmAq		3000 mmAq		4000 mmAq		5000 mmAq		6000 mmAq		7000 mmAq		8000 mmAq	
		m ³ /min	kW	m ³ /min	kW	m ³ /min	kW	m ³ /min	kW	m ³ /min	kW	m ³ /min	kW	m ³ /min	kW	m ³ /min	kW
G32	1450	0.44	0.11	0.42	0.22	0.31	0.39	0.37	0.38	0.35	0.46	0.35	0.54				
	1600	0.49	0.12	0.46	0.24	0.35	0.43	0.42	0.42	0.40	0.51	0.39	0.60				
	1750	0.54	0.13	0.51	0.26	0.38	0.49	0.47	0.46	0.46	0.56	0.45	0.65				
	1900	0.60	0.15	0.57	0.28	0.41	0.54	0.53	0.50	0.51	0.60	0.50	0.71				
	2050	0.64	0.16	0.61	0.30	0.44	0.59	0.57	0.54	0.55	0.65	0.54	0.76				
	2200	0.69	0.17	0.67	0.33	0.48	0.34	0.63	0.58	0.61	0.70	0.60	0.82				
	2350	0.74	0.18	0.72	0.35	0.51	0.69	0.68	0.62	0.67	0.75	0.65	0.87				
G40	1450	0.65	0.17	0.62	0.32	0.59	0.47	0.56	0.57	0.53	0.69	0.52	0.81				
	1600	0.74	0.18	0.68	0.36	0.65	0.52	0.63	0.63	0.61	0.76	0.59	0.89				
	1750	0.81	0.20	0.76	0.39	0.74	0.57	0.71	0.69	0.69	0.83	0.67	0.98				
	1900	0.89	0.22	0.85	0.42	0.81	0.62	0.79	0.75	0.76	0.91	0.76	1.06				
	2050	0.95	0.24	0.91	0.46	0.89	0.66	0.86	0.81	0.83	0.98	0.82	1.14				
	2200	1.03	0.25	1.00	0.49	0.97	0.71	0.94	0.87	0.92	1.02	0.90	1.23				
	2350	1.12	0.27	1.07	0.52	1.04	0.76	1.02	0.93	1.00	1.12	0.97	1.31				
GL40	1450	0.87	0.22	0.83	0.43	0.78	0.63	0.74	0.76	0.70	0.92	0.69	1.08				
	1600	0.98	0.24	0.91	0.47	0.87	0.69	0.83	0.84	0.81	1.02	0.79	1.19				
	1750	1.08	0.27	1.01	0.52	0.98	0.76	0.95	0.92	0.92	1.11	0.89	1.30				
	1900	1.19	0.29	1.13	0.56	1.08	0.82	1.06	1.00	1.02	1.21	1.01	1.41				
	2050	1.27	0.31	1.21	0.61	1.19	0.89	1.14	1.08	1.11	1.30	1.09	1.53				
	2200	1.38	0.34	1.34	0.65	1.29	0.95	1.25	1.16	1.23	1.40	1.20	1.64				
	2350	1.49	0.36	1.43	0.70	1.39	1.02	1.36	1.24	1.34	1.49	1.30	1.75				
G50	850	1.08	0.42	0.87	0.81	0.70	1.18	0.55	1.53	0.42	1.85	0.32	2.17	0.23	2.47	0.16	2.76
	1000	1.42	0.49	1.21	0.95	1.05	1.39	0.90	1.80	0.77	2.18	0.66	2.55	0.58	2.91	0.51	3.25
	1150	1.79	0.57	1.56	1.10	1.39	1.60	1.25	2.07	1.11	2.51	1.02	2.93	0.93	3.34	0.86	3.74
	1300	2.13	0.64	1.93	1.24	1.76	1.81	1.60	2.34	1.47	2.83	1.36	3.32	1.29	3.78	1.23	4.22
	1450	2.47	0.71	2.27	1.38	2.10	2.02	1.95	2.62	1.82	3.16	1.72	3.70	1.63	4.22	1.58	4.71
	1600	2.84	0.79	2.61	1.53	2.46	2.22	2.30	2.89	2.17	3.49	2.08	4.08	1.99	4.65	1.92	5.20
	1750	3.17	0.86	2.96	1.67	2.80	2.43	2.65	3.16	2.52	3.81	2.43	4.46	2.33	5.09	2.27	5.69
G65	850	2.11	0.63	1.90	1.22	1.73	1.77	1.57	2.30	1.43	2.80	1.36	3.28	1.23	3.74	1.11	4.14
	1000	2.63	0.74	2.40	1.43	2.29	2.09	2.10	2.71	1.94	3.30	1.80	3.86	1.73	4.40	1.61	4.87
	1150	3.18	0.85	2.95	1.65	2.75	2.40	2.60	3.11	2.45	3.79	2.33	4.44	2.24	5.06	2.13	5.61
	1300	3.77	0.96	3.53	1.86	3.31	2.71	3.12	3.52	2.96	4.28	2.82	5.02	2.73	5.72	2.63	6.34
	1450	4.38	1.07	4.13	2.08	3.91	3.02	3.72	3.92	3.55	4.78	3.39	5.59	3.28	6.38	3.17	7.07
	1600	5.00	1.18	4.75	2.29	4.53	3.34	4.33	4.33	4.15	5.27	4.00	6.17	3.86	7.04	3.74	7.80
	1750	5.64	1.29	5.39	2.51	5.16	3.65	4.95	4.73	4.77	5.77	4.61	6.75	4.47	7.70	4.35	8.53
G80	850	3.25	1.13	2.91	2.13	2.60	3.06	2.33	3.86	2.09	4.71	1.88	5.47	1.70	6.15	1.53	6.79
	1000	4.04	1.34	3.69	2.50	3.38	3.60	3.10	4.55	2.86	5.54	2.65	6.43	2.46	7.24	2.29	7.99
	1150	4.90	1.52	4.53	2.88	4.22	4.14	3.93	5.23	3.68	6.37	3.46	7.40	3.27	8.33	3.10	9.19
	1300	5.80	1.72	5.43	3.25	5.10	4.68	4.80	5.91	4.55	7.20	4.32	8.36	4.12	9.41	3.94	10.39
	1450	6.73	1.91	6.36	3.63	6.02	5.22	5.72	6.59	5.46	8.03	5.22	9.33	5.02	10.50	4.83	11.59
	1600	7.70	2.11	7.31	4.00	6.97	5.76	6.66	7.27	6.39	8.86	6.15	10.29	5.94	11.59	5.75	12.79
	1750	8.68	2.31	8.29	4.38	7.94	6.30	7.62	7.96	7.35	9.69	7.10	11.25	6.89	12.67	6.70	13.99

GREATECH ROOTS BLOWER

Model	RPM	Pressure(mmAq)				Capacity(m ³ /min)						Power(kW)					
		1000 mmAq		2000 mmAq		3000 mmAq		4000 mmAq		5000 mmAq		6000 mmAq		7000 mmAq		8000 mmAq	
		m ³ /min	kW	m ³ /min	kW	m ³ /min	kW	m ³ /min	kW	m ³ /min	kW	m ³ /min	kW	m ³ /min	kW	m ³ /min	kW
G100	850	5.97	1.59	5.34	3.09	4.78	4.34	4.28	5.41	3.85	6.59	3.46	7.65	3.11	8.65	2.81	9.53
	1000	7.11	1.88	6.49	3.64	5.94	5.10	5.45	6.36	5.03	7.75	4.65	9.00	4.31	10.18	4.02	11.21
	1150	8.37	2.16	7.75	4.18	7.21	5.87	6.72	7.32	6.29	8.91	5.92	10.35	5.59	11.71	5.29	12.89
	1300	9.64	2.44	9.02	4.73	8.48	6.63	7.98	8.27	7.57	10.08	7.18	11.70	6.85	13.23	6.56	14.57
	1450	10.94	2.72	10.33	5.27	9.78	7.40	9.29	9.23	8.86	11.24	8.48	13.06	8.15	14.76	7.85	16.25
	1600	12.21	3.00	11.60	5.82	11.05	8.16	10.56	10.18	10.13	12.40	9.75	14.41	9.41	16.29	9.12	17.93
	1750	13.43	3.28	12.82	6.36	12.28	8.93	11.79	11.14	11.37	13.57	10.98	15.76	10.65	17.81	10.36	19.62
G125	750	11.86	3.02	11.30	5.85	10.76	8.19	10.25	10.63	9.76	12.42	9.29	14.55	8.85	16.58	8.43	17.99
	900	14.17	3.55	13.56	6.88	12.97	9.64	12.41	12.50	11.88	14.62	11.37	17.11	10.88	19.50	10.41	21.16
	1050	16.54	4.08	15.90	7.91	15.29	11.08	14.70	14.38	14.13	16.81	13.59	19.68	13.07	22.43	12.57	24.34
	1200	18.97	4.61	18.33	8.94	17.71	12.53	17.11	16.25	16.53	19.00	15.97	22.25	15.43	25.36	14.91	27.51
	1350	21.48	5.14	20.85	9.97	20.25	13.97	19.66	18.13	19.08	21.20	18.53	24.82	17.99	28.28	17.46	30.69
	1500	24.06	5.68	23.47	11.01	22.90	15.42	22.34	20.00	21.79	23.39	21.26	27.38	20.74	31.21	20.24	33.86
	1650	26.71	6.21	26.18	12.04	25.67	16.86	25.17	21.88	24.67	25.58	24.19	29.95	23.71	34.13	23.25	37.03
G150	750	15.58	3.87	14.99	7.50	14.41	10.50	13.85	13.62	13.32	15.93	12.81	18.65	12.32	21.25	11.84	23.06
	900	18.52	4.55	17.89	8.82	17.29	12.35	16.70	16.03	16.14	18.74	15.59	21.94	15.06	25.01	14.56	27.13
	1050	21.51	5.23	20.88	10.14	20.27	14.21	19.68	18.43	19.11	21.55	18.55	25.23	18.01	28.76	17.49	31.20
	1200	24.56	5.91	23.96	11.46	23.37	16.06	22.80	20.84	22.25	24.36	21.71	28.52	21.18	32.51	20.66	35.27
	1350	27.66	6.60	27.12	12.79	26.59	17.91	26.07	23.24	25.56	27.17	25.06	31.82	24.57	36.26	24.08	39.34
	1500	30.83	7.28	30.38	14.11	29.93	19.77	29.49	25.64	29.05	29.98	28.62	35.11	28.20	40.01	27.78	43.41
	1650	34.06	7.96	33.72	15.43	33.39	21.62	33.06	28.05	32.73	32.80	32.41	38.40	32.09	43.76	31.77	47.48
G200	600	19.03	5.05	17.79	9.72	16.94	13.91	16.03	17.83	15.56	21.43	14.88	24.78	14.26	27.89	13.71	30.80
	750	25.22	6.31	24.02	12.15	23.32	17.39	22.42	22.29	21.64	26.79	20.97	30.98	20.36	34.86	19.86	38.50
	900	30.87	7.57	29.71	14.58	28.98	20.87	28.14	26.74	27.24	32.15	26.71	37.18	26.18	41.84	25.67	46.20
	1050	36.73	8.83	35.56	17.01	34.86	24.35	34.01	31.20	33.25	37.51	32.59	43.37	31.95	48.81	31.54	53.90
	1200	42.15	10.10	41.32	19.44	40.27	27.82	39.41	35.66	38.67	42.87	38.02	49.57	37.46	55.78	37.02	61.59
	1350	47.89	11.36	47.04	21.87	46.03	31.30	45.22	40.12	44.55	48.23	44.06	55.77	43.54	62.75	43.07	69.29
	1500	53.21	12.62	52.68	24.30	52.16	34.78	51.49	44.57	50.83	53.59	50.22	61.96	49.53	69.73	49.03	76.99
G250	600	30.43	7.54	28.95	14.30	27.76	20.54	26.23	26.46	24.89	31.79	24.09	36.72	23.21	41.01	22.24	45.53
	750	38.93	9.42	37.61	17.87	36.56	25.68	35.19	33.08	34.00	39.74	33.29	45.90	32.51	51.27	31.65	56.92
	900	47.43	11.30	46.27	21.45	45.35	30.81	44.16	39.69	43.12	47.68	42.50	55.07	41.81	61.52	41.06	68.30
	1050	55.92	13.19	54.94	25.02	54.15	35.95	53.12	46.31	52.23	55.63	51.70	64.25	51.11	71.77	50.47	79.68
	1200	64.42	15.07	63.60	28.60	62.94	41.08	62.09	52.92	61.35	63.58	60.90	73.43	60.41	82.03	59.87	91.07
	1350	72.92	16.95	72.26	32.17	71.74	46.22	71.05	59.54	70.46	71.52	70.10	82.61	69.71	92.28	69.28	102.45
	1500	81.42	18.84	80.93	35.75	80.53	51.35	80.02	66.15	79.57	79.47	79.31	91.79	79.01	102.53	78.69	113.83
G300	750	69.42	15.55	65.37	29.80	63.26	43.93	61.29	56.32	59.47	69.41	58.03	81.27	56.06	92.29	55.01	103.51
	900	89.07	19.44	85.01	37.25	82.92	54.91	80.97	70.40	79.12	86.76	77.68	101.58	75.72	115.36	74.65	129.38
	1050	108.73	23.33	104.66	44.70	102.56	65.89	100.59	84.49	98.75	104.11	97.32	121.90	95.35	138.43	94.30	155.26
	1200	128.38	27.21	124.27	52.15	122.28	76.87	120.28	98.57	118.40	121.47	116.98	142.22	115.01	161.51	113.92	181.14
	1350	148.03	31.10	143.96	59.60	141.86	87.86	139.98	112.65	138.09	138.82	136.69	162.53	134.65	184.58	133.57	207.01
	1500	167.69	34.99	163.61	67.05	161.50	98.84	159.50	126.73	157.74	156.17	156.34	182.85	154.33	207.65	153.25	232.89
	1650	187.34	38.88	183.32	74.50	181.17	109.82	179.16	140.81	177.39	173.52	175.87	203.16	172.95	230.72	172.91	258.77

真空型性能表

Vacuum Type Performance Table

Model	RPM	Pressure(mmAq)						Capacity(m ³ /min)						Power(kW)			
		-1000 mmAq		-2000 mmAq		-2500 mmAq		-3000 mmAq		-3500 mmAq		-4000 mmAq		-4500 mmAq		-5000 mmAq	
		m ³ /min	kW	m ³ /min	kW	m ³ /min	kW	m ³ /min	kW	m ³ /min	kW	m ³ /min	kW	m ³ /min	kW	m ³ /min	kW
G40V	1450	0.87	0.22	0.82	0.43	0.78	0.53	0.76	0.60	0.71	0.68	0.69	0.76				
	1600	0.98	0.24	0.90	0.47	0.86	0.59	0.86	0.66	0.82	0.75	0.79	0.83				
	1750	1.08	0.27	1.00	0.52	0.98	0.64	0.98	0.72	0.93	0.82	0.89	0.91				
	1900	1.19	0.29	1.12	0.56	1.07	0.70	1.09	0.78	1.03	0.89	1.01	0.99				
	2050	1.27	0.31	1.20	0.61	1.18	0.75	1.18	0.84	1.12	0.96	1.09	1.07				
	2200	1.38	0.34	1.33	0.65	1.27	0.81	1.29	0.90	1.24	1.04	1.20	1.15				
	2350	1.40	0.36	1.42	0.70	1.38	0.86	1.40	0.96	1.35	1.11	1.30	1.22				
G50V	850	1.02	0.42	0.84	0.81	0.74	0.99	0.63	1.18	0.53	1.36	0.37	1.53	0.28	1.70	0.14	1.87
	1000	1.35	0.49	1.17	0.95	1.07	1.18	0.96	1.39	0.85	1.59	0.71	1.80	0.61	2.00	0.47	2.19
	1150	1.68	0.57	1.51	1.10	1.40	1.35	1.29	1.59	1.18	1.84	1.04	2.07	0.94	2.30	0.81	2.53
	1300	2.01	0.64	1.84	1.24	1.74	1.52	1.63	1.81	1.52	2.08	1.37	2.34	1.28	2.60	1.14	2.85
	1450	2.34	0.71	2.17	1.38	2.07	1.71	1.96	2.01	1.85	2.31	1.70	2.61	1.61	2.90	1.47	3.18
	1600	2.68	0.78	2.50	1.52	2.40	1.88	2.29	2.22	2.28	2.56	2.03	2.88	1.94	3.20	1.80	3.51
	1750	3.01	0.86	2.83	1.66	2.73	2.05	2.62	2.43	2.51	2.79	2.36	3.16	2.27	3.50	2.13	3.84
G65V	850	2.15	0.67	1.97	1.30	1.85	1.60	1.73	1.90	1.60	2.18	1.45	2.46	1.30	2.73	1.12	2.99
	1000	2.68	0.79	2.50	1.53	2.39	1.89	2.26	2.23	2.13	2.57	1.98	2.89	1.82	3.21	1.65	3.52
	1150	3.21	0.90	3.04	1.76	2.93	2.17	2.79	2.57	2.66	2.95	2.51	3.33	2.36	3.69	2.18	4.05
	1300	3.75	1.03	3.56	1.99	3.45	2.45	3.33	2.90	3.19	3.34	3.05	3.77	2.89	4.17	2.72	4.58
	1450	4.27	1.15	4.10	2.22	3.99	2.73	3.85	3.24	3.73	3.73	3.57	4.19	3.42	4.66	3.24	5.11
	1600	4.81	1.26	4.64	2.45	4.52	3.01	4.39	3.57	4.25	4.47	4.11	4.63	3.96	5.14	3.78	5.63
	1750	5.35	1.38	5.16	2.68	5.05	3.30	4.92	3.91	4.79	4.49	4.65	5.06	4.49	5.62	4.32	6.17
G80V	850	3.34	1.14	2.91	2.17	2.68	2.66	2.33	3.13	2.16	3.57	1.88	4.00	1.59	4.41	1.27	4.80
	1000	4.26	1.34	3.84	2.56	3.61	3.13	3.36	3.67	3.09	4.20	2.81	4.70	2.51	5.19	2.19	5.65
	1150	5.19	1.53	4.77	2.94	4.53	3.59	4.28	4.22	4.02	4.83	3.73	5.41	3.44	5.97	3.12	6.50
	1300	6.12	1.74	5.70	3.32	5.46	4.07	5.21	4.78	4.94	5.46	4.67	6.11	4.37	6.74	4.05	7.35
	1450	7.05	1.94	6.62	3.70	6.39	4.54	6.14	5.33	5.87	6.09	5.59	6.82	5.29	7.52	4.97	8.20
	1600	7.97	2.14	7.55	4.09	7.31	5.00	7.07	5.88	6.80	6.72	6.52	7.52	6.22	8.30	5.90	9.04
	1750	8.90	2.33	8.48	4.48	8.24	5.47	7.99	6.42	7.73	7.35	7.45	8.23	7.15	9.07	6.83	9.90
G100V	850	5.96	1.59	5.35	3.05	5.00	3.73	4.61	4.37	4.21	4.99	3.78	5.59	3.32	6.17	2.82	6.73
	1000	7.26	1.87	6.64	3.58	6.29	4.37	5.91	5.15	5.51	5.88	5.08	6.59	4.61	7.26	4.12	7.92
	1150	8.56	2.15	7.94	4.11	7.59	5.03	7.21	5.92	6.81	6.76	6.38	7.57	5.91	8.35	5.42	9.10
	1300	9.86	2.44	9.24	4.65	8.89	5.69	8.51	6.69	8.11	7.64	7.67	8.56	7.21	9.44	6.72	10.29
	1450	11.15	2.71	10.54	5.19	10.19	6.34	9.81	7.46	9.40	8.53	8.97	9.55	8.51	10.53	8.01	11.48
	1600	12.45	2.99	11.83	5.72	11.48	7.00	11.10	8.23	10.70	9.41	10.27	10.54	9.81	11.62	9.31	12.66
	1750	13.75	3.28	13.13	6.26	12.78	7.66	12.40	9.00	12.00	10.29	11.57	11.52	11.10	12.71	1.61	13.84
G125V	750	11.86	3.02	11.35	5.85	10.81	6.96	10.35	8.29	9.81	9.19	9.32	10.18	8.87	10.94	8.43	11.15
	900	14.17	3.55	13.62	6.88	13.04	8.19	12.54	9.75	11.94	10.82	11.40	11.98	10.90	12.87	10.41	13.12
	1050	16.54	4.08	15.98	7.91	15.36	9.42	14.85	11.21	14.20	12.44	13.63	13.78	13.09	14.80	12.57	15.09
	1200	18.97	4.61	18.42	8.94	17.80	10.65	17.28	12.68	16.62	14.06	16.02	15.57	15.46	16.73	14.91	17.06
	1350	21.48	5.14	20.96	9.97	20.35	11.88	19.85	14.14	19.18	15.68	18.58	17.37	18.02	18.67	17.46	19.03
	1500	24.06	5.68	23.59	11.01	23.01	13.11	22.56	15.60	21.90	17.31	21.33	19.17	20.79	20.60	20.24	20.99
	1650	26.71	6.21	26.31	12.04	25.80	14.33	25.42	17.06	24.80	18.93	24.26	20.97	23.76	22.53	23.25	22.96

GREATECH ROOTS BLOWER

Model	RPM	Pressure(mmAq)				Capacity(m ³ /min)						Power(kW)					
		-1000 mmAq		-2000 mmAq		-2500 mmAq		-3000 mmAq		-3500 mmAq		-4000 mmAq		-4500 mmAq		-5000 mmAq	
		m ³ /min	kW	m ³ /min	kW	m ³ /min	kW	m ³ /min	kW	m ³ /min	kW	m ³ /min	kW	m ³ /min	kW	m ³ /min	kW
G150V	750	13.72	3.39	12.93	6.49	12.50	7.94	12.04	9.33	11.54	10.66	11.00	11.94	10.43	13.16	9.84	14.35
	900	16.89	4.07	16.11	7.79	15.69	9.52	15.22	11.20	14.71	12.79	14.18	14.32	13.61	15.80	13.02	17.22
	1050	20.07	4.75	19.29	9.08	18.87	11.11	18.40	13.05	17.89	14.92	17.37	16.72	16.79	18.43	16.19	20.10
	1200	23.26	5.43	22.46	10.38	22.04	12.70	21.58	14.92	21.07	17.05	20.54	19.10	19.97	21.07	19.37	22.96
	1350	26.43	6.11	25.65	11.67	25.22	14.28	24.76	16.79	24.25	19.18	23.72	21.49	23.14	23.70	22.56	25.83
	1500	29.61	6.78	28.83	12.97	28.41	15.87	27.93	18.66	27.43	21.32	26.90	23.87	26.33	26.34	25.73	28.70
1650	32.80	7.46	32.01	14.27	31.58	17.46	31.12	20.51	30.15	23.45	30.08	26.27	29.51	28.97	28.91	31.58	
G200V	600	17.52	4.91	16.47	9.41	15.88	11.51	15.31	13.52	14.64	15.46	13.89	17.32	13.16	19.10	12.34	20.82
	750	23.36	6.14	22.31	11.75	21.72	14.38	21.15	16.90	20.48	19.33	19.73	21.64	19.00	23.87	18.18	26.02
	900	29.20	7.38	28.15	14.11	27.56	17.27	26.99	20.28	26.32	23.18	25.57	25.97	24.84	28.65	24.02	31.23
	1050	35.04	8.61	33.99	16.46	33.40	20.14	32.83	23.67	32.16	27.05	31.42	30.30	30.68	33.42	29.86	36.43
	1200	40.88	9.84	39.83	18.81	39.24	23.01	38.67	27.05	38.00	30.92	37.26	34.63	36.52	38.20	35.70	41.64
	1350	46.72	11.06	45.67	21.16	45.08	25.89	44.51	30.43	43.84	34.77	43.10	38.96	42.36	42.98	41.54	46.84
1500	52.56	12.29	51.51	23.52	50.92	28.77	50.35	33.81	49.68	38.64	48.94	43.29	48.20	47.76	47.38	52.05	
G250V	600	28.55	7.51	27.01	14.37	24.05	17.58	25.16	20.66	24.15	23.62	23.02	26.45	21.83	29.18	20.58	31.81
	750	37.47	9.39	35.93	17.97	35.03	21.97	34.08	25.82	33.07	29.52	31.94	33.07	30.76	36.48	29.50	39.76
	900	46.40	11.27	44.85	21.56	43.96	26.37	43.00	30.99	41.99	35.42	40.86	39.68	39.68	43.78	38.43	47.72
	1050	55.32	13.14	53.78	25.14	52.88	30.76	51.93	36.15	50.91	41.33	49.79	46.29	48.60	51.06	47.35	55.66
	1200	64.24	15.02	62.70	28.73	61.80	35.16	60.85	41.32	59.84	47.23	58.71	52.90	57.52	58.36	56.27	63.61
	1350	73.16	16.90	71.62	32.33	70.72	39.55	69.77	46.49	68.72	53.14	67.63	59.52	66.45	65.66	65.19	71.57
1500	82.09	18.78	80.54	35.92	79.65	43.95	78.69	51.65	77.68	59.03	76.55	66.14	75.37	72.96	74.12	79.52	
G300V	600	69.42	15.55	65.69	31.37	62.63	39.40	60.68	46.94	58.87	52.58	57.45	58.89	56.06	64.54	54.46	71.88
	750	89.07	19.44	85.44	39.21	82.09	49.25	80.16	58.67	78.33	65.73	76.90	73.61	75.72	80.67	73.91	89.85
	900	108.73	23.33	105.18	47.05	101.54	59.10	99.59	70.40	97.77	78.87	96.35	88.33	95.35	96.81	93.35	107.82
	1050	128.38	27.21	124.89	54.90	121.06	68.95	119.08	82.14	117.22	92.02	115.81	103.05	115.01	112.94	112.78	125.79
	1200	148.03	31.10	144.68	62.74	140.44	78.79	138.58	93.87	136.71	105.16	135.33	117.78	134.65	129.08	132.23	143.76
	1350	167.69	34.99	164.43	70.58	159.88	88.64	157.90	105.61	156.16	118.31	154.78	132.50	154.33	145.21	151.72	161.73
1500	187.34	38.88	184.24	78.42	179.36	98.49	177.37	117.34	175.62	131.46	174.11	147.22	172.95	161.35	171.18	179.70	

GREATECH ROOTS BLOWER

安裝圖

Installations

壓送型 Pressure Type

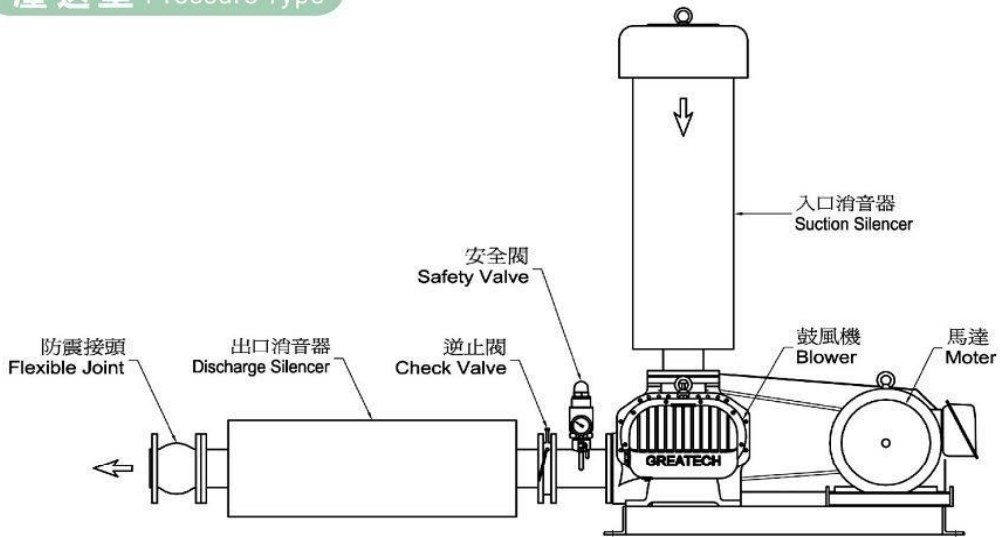

真空型 Vacuum Type

